

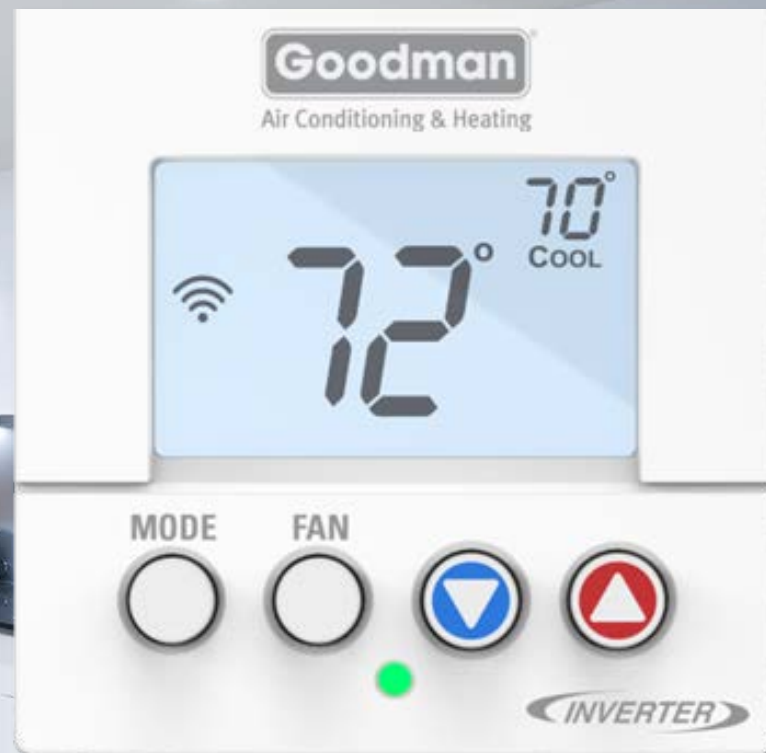

Air Conditioning & Heating



# Goodman GTST Connected Thermostat Installation & Commissioning

Technical Training Module TRC-13

# Disclaimers

---

This material provides technical information that is to only be used by appropriately trained and certified HVAC-R installers and technicians who have agreed to the terms and conditions available here at <https://www.daikincity.com/DaikinCityB2BTermsOfUse.html>. If you have not agreed to these terms and conditions, you may not use or view this material, and you assume responsibility for any injury or property, system or equipment damage which may result. If you have agreed to these terms, you also agree, by viewing or using this material, that this material, by its nature, cannot include a discussion of everything necessary to effect a proper installation or repair of HVAC-R equipment, nor can it address every possible scenario or environment a technician or installer may encounter. Accordingly, this material should not be considered as recommendations for best practices and will not be considered installation or repair instructions to the extent of any conflict with Daikin- or Goodman-issued manuals and specifications, or industry standards and regulations. Each installer or technician remains fully responsible for ensuring proper installation or repair of the HVAC-R equipment being worked on, and you remain fully responsible for any injury or property, system or equipment damage which may result from your installation. ©2023 Daikin Comfort Technologies North America, Inc., all rights reserved; recording, copying, or distribution of this material is prohibited without express written permission from Daikin.



## Agenda

### Goodman GTST

System Configurations

Installing Goodman GTST

Commissioning Goodman GTST with Wi-Fi (recommended)

Commissioning Goodman GTST without Wi-Fi

Goodman Home App

# Goodman GTST Connected Thermostat

- Small footprint design.
- Commissioning and setup can be accomplished with the Goodman Installer app.
  - The end user will be able to control the system remotely through the Goodman Home app.
  - Additional option for commissioning is through the Goodman GTST thermostat buttons.
    - **Limited features.**
- Open API for integration into most home control systems, such as Crestron® and Control4®.

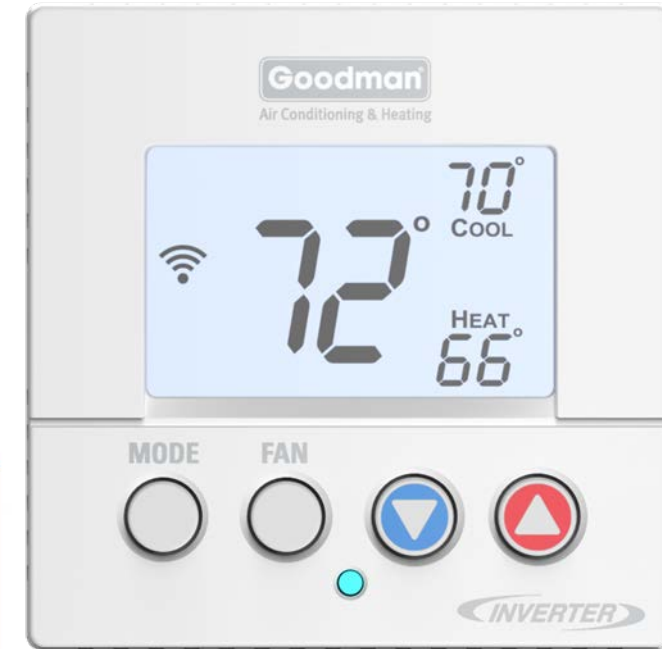

# Goodman GTST Interface

- Pressing or holding down a button or combination of buttons navigates the user through menus to view/adjust settings.

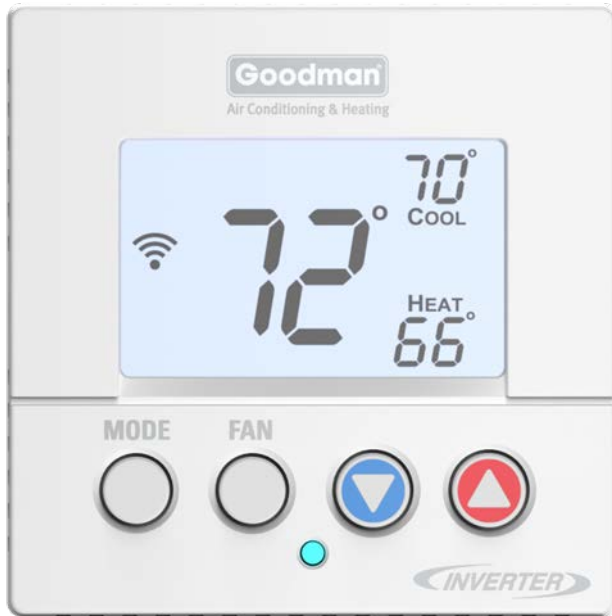

- Navigation through menus and adjusting can also be made using tactile gestures on the Goodman Home application from your mobile device.

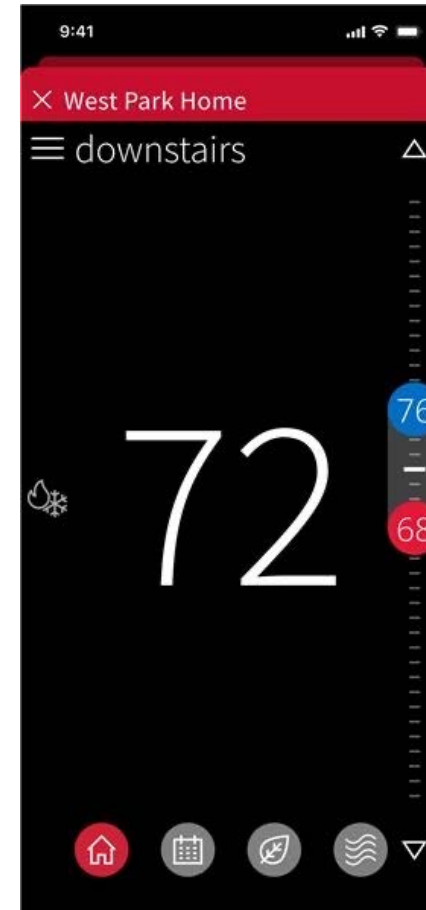

# Goodman GTST Messaging

- Goodman GTST messaging updates, confirms, and informs about selections you make during set-up and operation.
- There are four types of messages:
  - Status
    - Blue-cooling
    - Red- heating
  - Alerts
    - A critical alert is displayed as a message until resolved by the dealer and dismissed by putting the unit in “OFF” mode and then back into an operation mode.
  - Reminders and Prompts
  - Learn more/tips (App. Only)

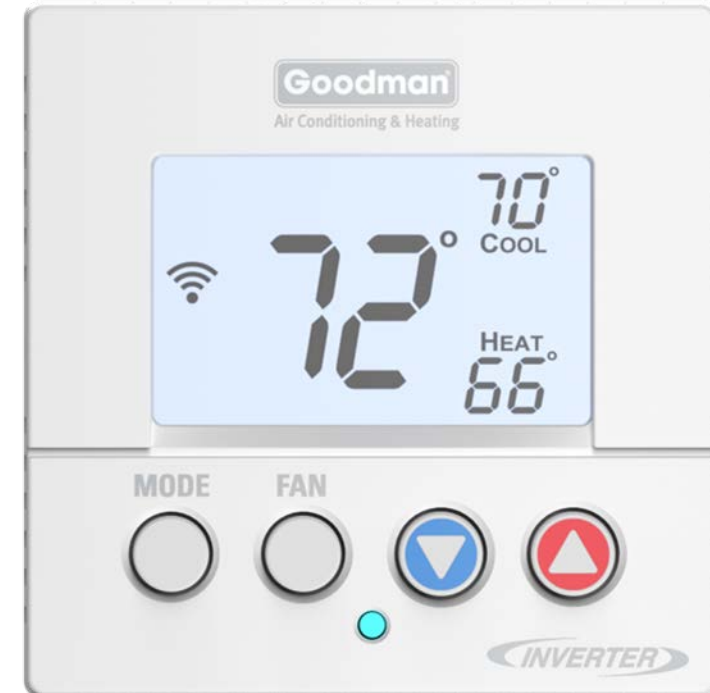

# Goodman GTST Packaging

- Quick reference cards are packaged with the thermostat to help answer questions during the installation and commissioning.

Dealers

## Install the thermostat

**Goodman**  
Air Conditioning & Heating

Use the supplied screws to secure the terminal plate to the wall.

Trim plate (optional)

Terminal plate

Screws

Thermostat

After connecting the wires, place thermostat over guide pins and press firmly until it snaps into place.

Once connected to power, commission the system. Scan the QR code to download the Goodman Installer Mobile App and follow the on-screen commissioning instructions.

Download the Goodman Installer app

Get help at [goodmanmfg.com](http://goodmanmfg.com)

Available on the App Store and Google Play

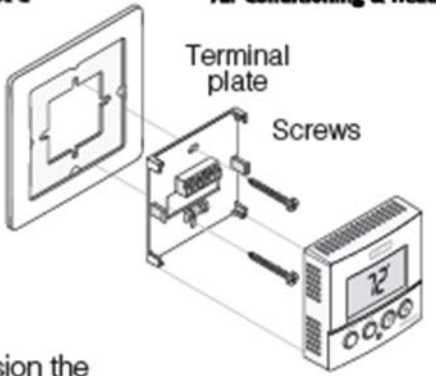

Scanning the QR code on the **bottom left** corner will link you to a website related to the title of the card.

## Agenda

Goodman GTST

### System Configurations

Installing Goodman GTST

Commissioning Goodman GTST with Wi-Fi (recommended)

Commissioning Goodman GTST without Wi-Fi

Goodman Home App



# Valid System Configurations

## Communicating indoor

- Air handler.
- Furnace.
- EEV coil.



## Communicating outdoor

- Heat pump.
- Air Conditioning.



| Outdoor      |          |          |          |        |
|--------------|----------|----------|----------|--------|
| GVXC20       | GSXV9    | GSXS6S   | GSXS60   |        |
| GSXC7        | GVZC20   | GSZV9    | GSZS60   | GSZC7  |
| Furnaces     |          |          |          |        |
| GMVM97       | GCVM97   | GMVC96   | GCVC96   | GMVC80 |
| GMVC8        | GCVC80   | GMVS96-U | GMVS80-U | GCVC8  |
| Coils        |          |          |          |        |
| CAPE/CAPEA   | CHPE     |          |          |        |
| Air Handlers |          |          |          |        |
| AHVE*1400    | MBVCxx00 |          |          |        |



## Agenda

Goodman GTST  
System Configurations

**Installing Goodman GTST**

Commissioning Goodman GTST with Wi-Fi (recommended)

Commissioning Goodman GTST without Wi-Fi

Goodman Home App

# Installing Goodman GTST

**DO NOT** install the thermostat where it can be affected by:

- Drafts or dead spots behind doors and in corners.
- Hot or cold air from ducts or ceiling fans.
- Radiant heat from the sun or appliances.
- Concealed pipes and chimneys.
- Unheated (uncooled) areas such as an outside wall.

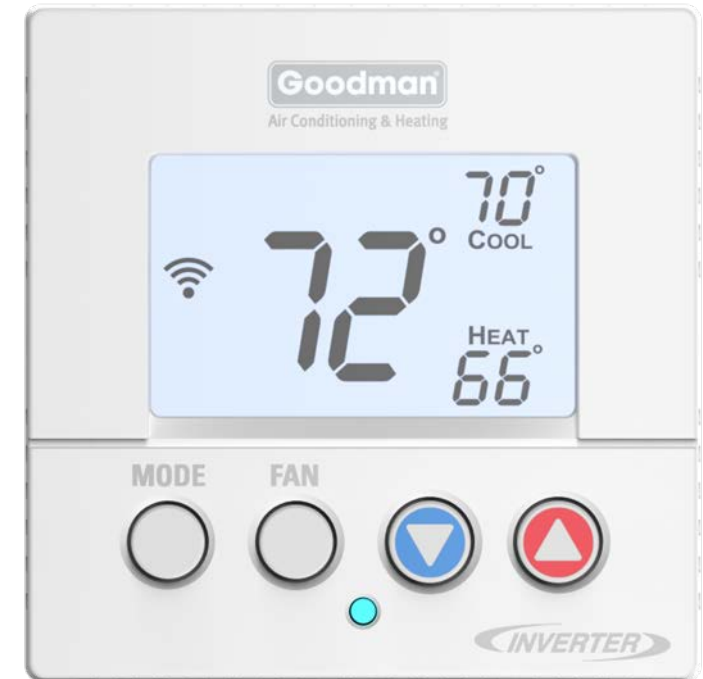

## Mount the thermostat to be:

- Leveled.
- Approximately 5' from the floor.
- On an interior wall using the included screws.

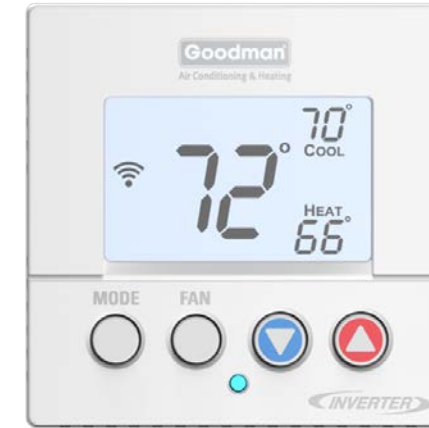
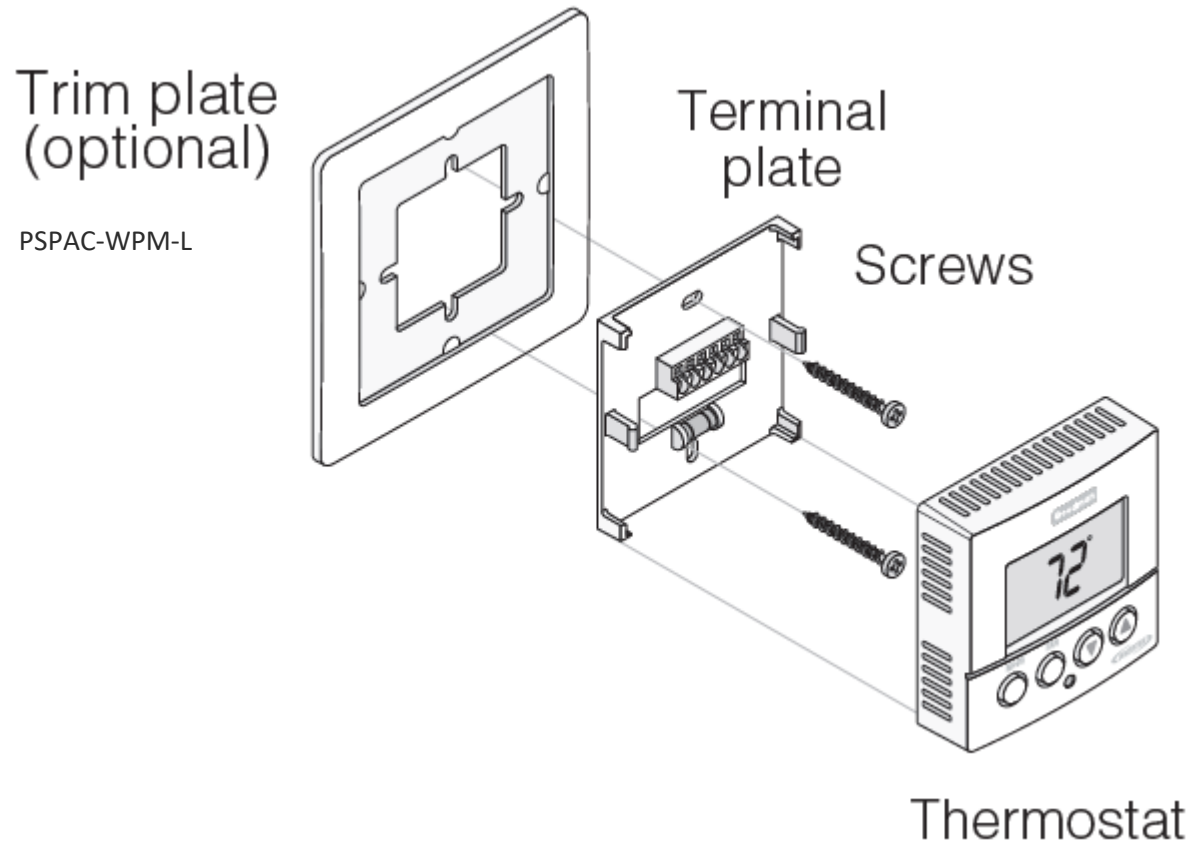

FLOOR

A horizontal line represents the floor level, with the word 'FLOOR' written below it.

# Wiring Thermostat To Communicating Systems

- Maximum wire distance between the Thermostat and the indoor unit should not exceed **125 feet using 18 gauge wire**. Standard non-stranded thermostat wire is acceptable.
- **Check for proper voltage before and after wiring is installed.**
  - 0.6VDC between Data 1 and 2
- Wiring communicating indoor unit to communicating outdoor units.
  - Connect **1, 2, C and R** from the GTST, to **1, 2, C and R** at the **indoor** unit.
  - Connect wires **1 and 2** from the **indoor** unit to **1 and 2** at the **outdoor** unit.
- **Note:** The Goodman GTST is labeled **1, 2, C, R**. **If wired incorrectly, you will receive a communication error, or your equipment may not be recognized and displayed.**

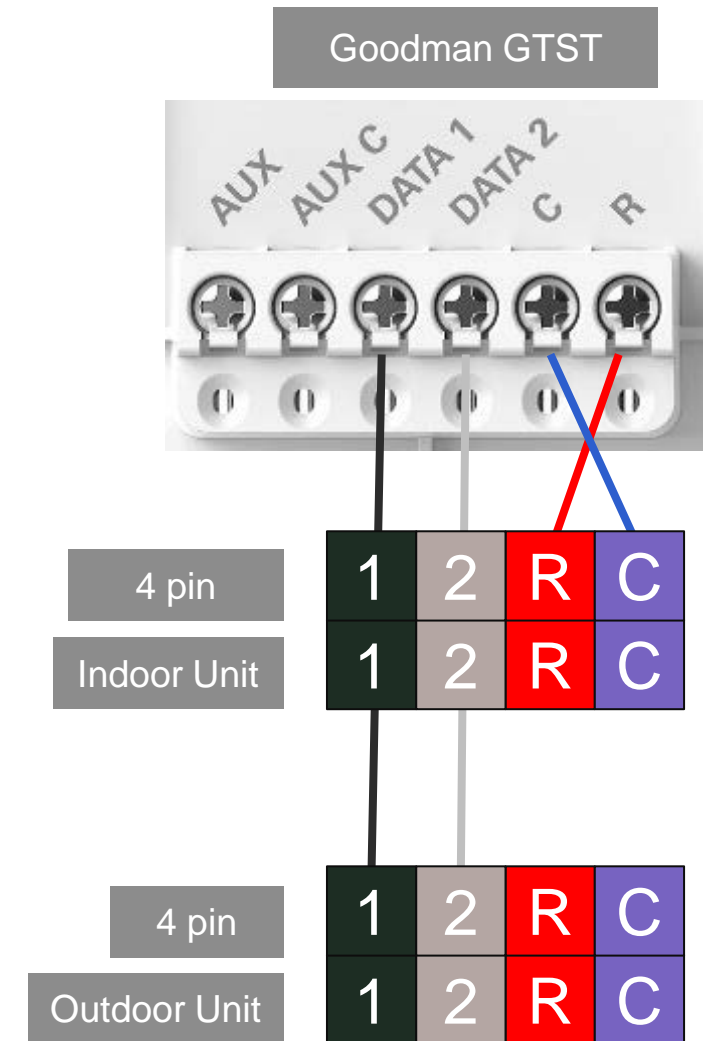

# Aux Wiring

- The thermostat's Aux output is a dry contact that closes the connection to turn on the Aux equipment.
- A 24V AC control signal must be routed through the aux contact of the thermostat.

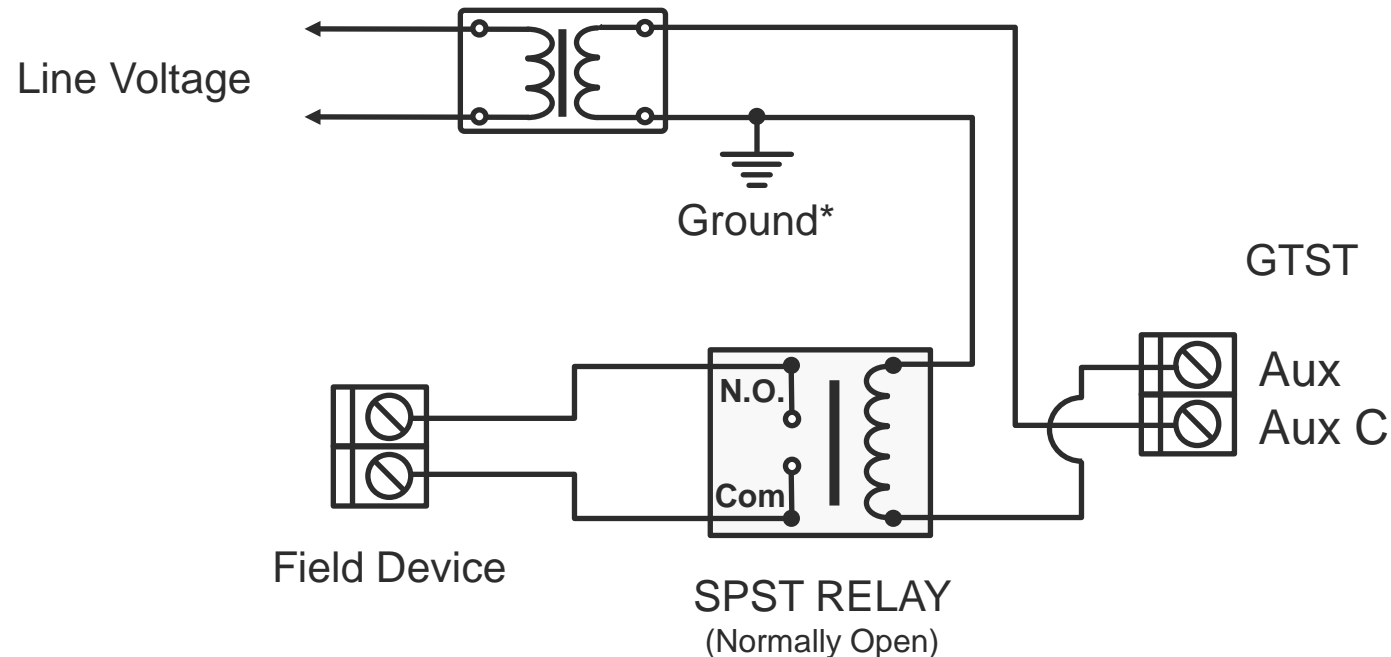

\*The terminals are selected in the GTST installer app.

Note: It is recommended to use a minimum of 18-gauge wire. Standard non-stranded thermostat wire is acceptable.  
Maximum operating length of wire is 125 ft.

# Use The Coolcloud™ App. To Verify Furnace Firmware

- The GTST must be utilized when setting up communication.
  - **Note:** This system is **NOT** Comfortbridge controlled. If wired to a communicating furnace, the installer must check for critical OTA updates through the CoolCloud app. prior to commissioning.
    - **Do not energize the controller until you have verified the critical OTA is complete.**

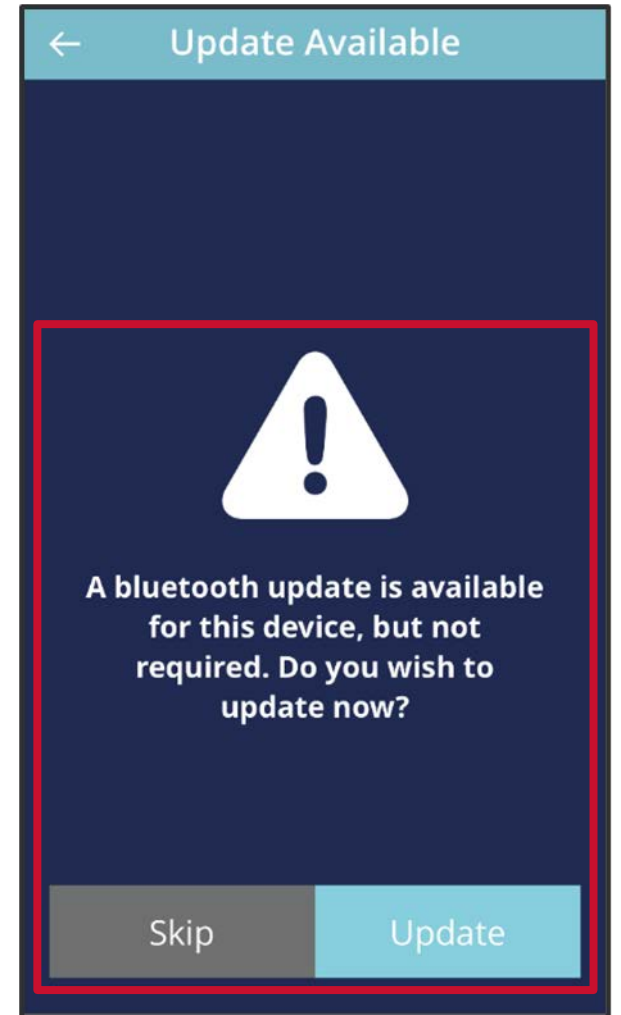

## Agenda

Goodman GTST

System Configurations

Installing Goodman GTST

**Commissioning Goodman GTST with Wi-Fi (recommended)**

Commissioning Goodman GTST without Wi-Fi

Goodman Home App



# Cloud Commissioning (Wi-Fi)

- Download the Goodman Installer app. from your respective app. store.
- You do not need to create an account to log in
  - User ID and password (case sensitive):
    - User = Goodman
    - Password = Dealer
- System profiles enable the technician to modify settings from the app. and upload those settings to the thermostat.

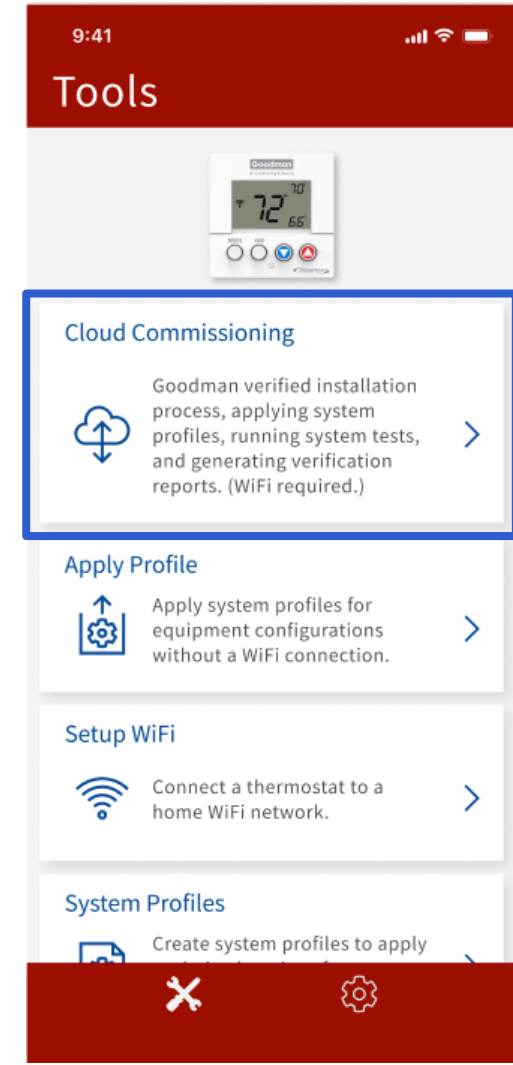
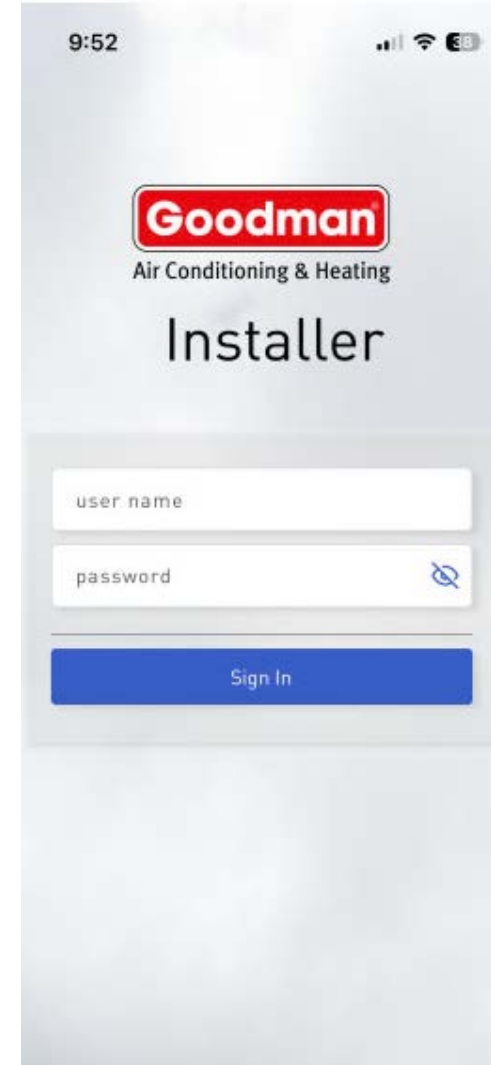

# Create A Job Based On Location

- Every job needs the location details.
- Click on the “+” sign to add location details and continue.
  - The user can use their GPS location to automatically fill in the address.

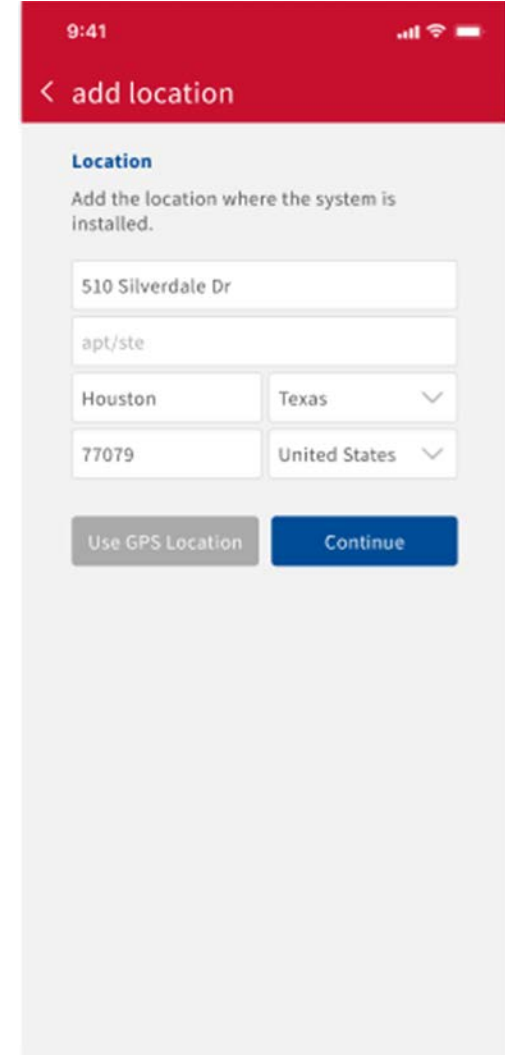
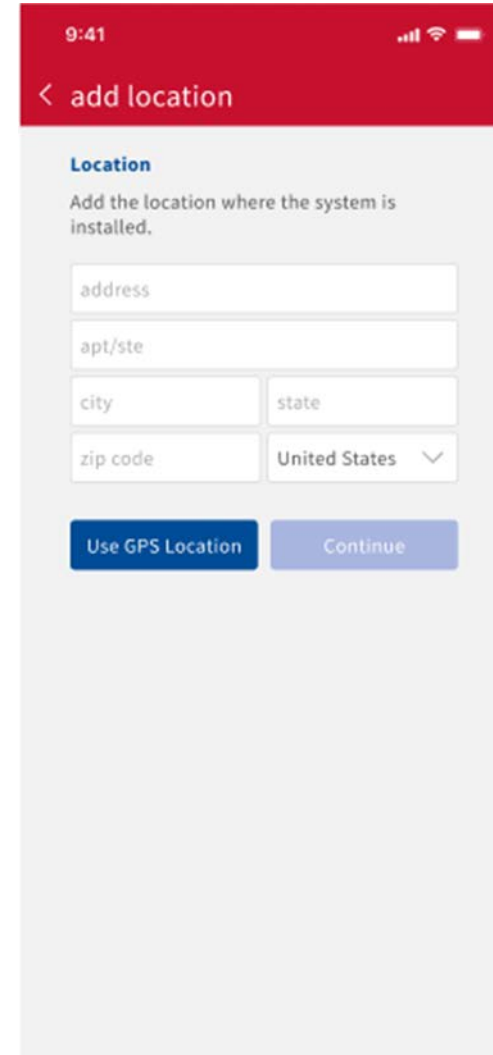
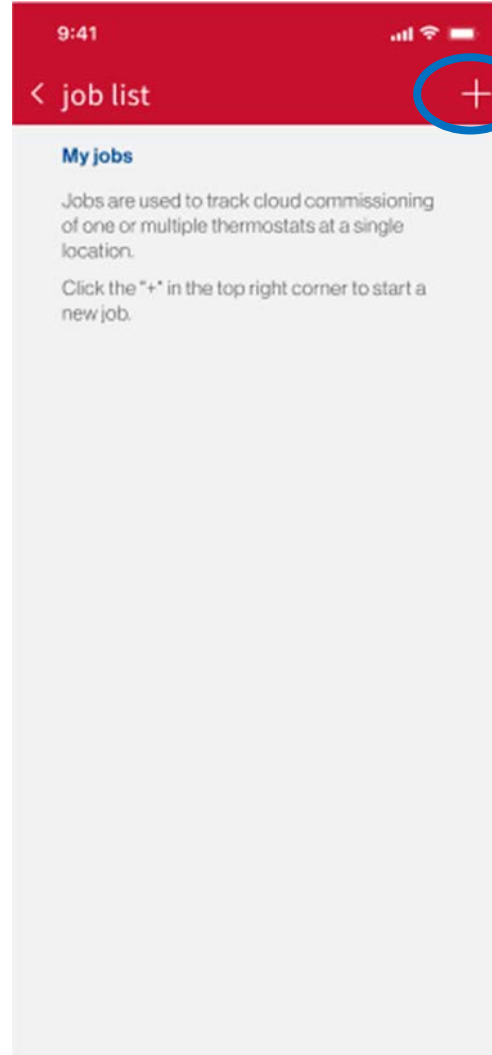

# Add Thermostat To Job And Configure For Zoning If Needed

- Add thermostat by tapping on + in top right corner then scanning the 2D bar code or entering thermostat DKNS # manually.
  - The 2D bar code is found on the terminal subbase.
  - DKN # is found by navigating through the thermostat menus.
- Zone board configuration can be seen by sliding the toggle button to the right.
  - If a thermostat is connected to a zone board and not zone one, then equipment info will not be available.

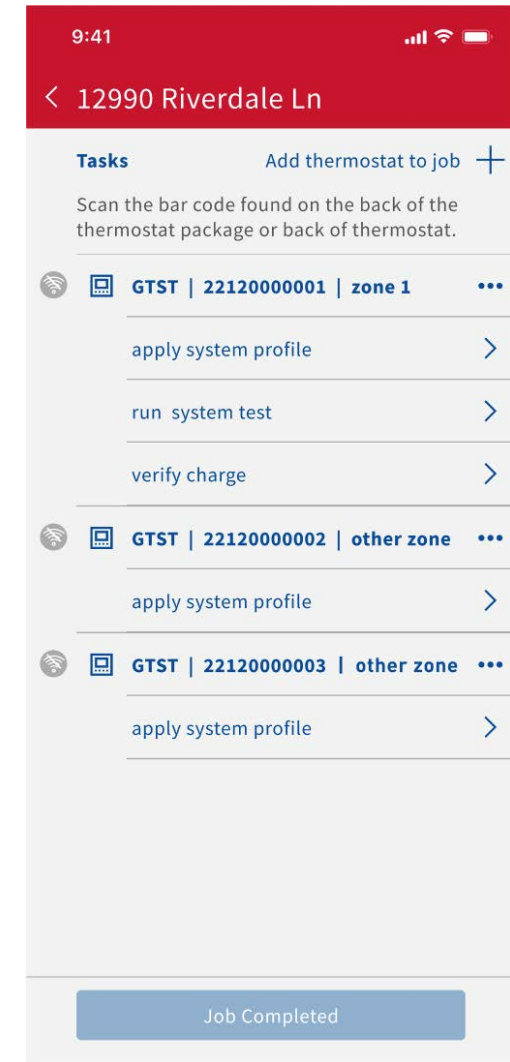
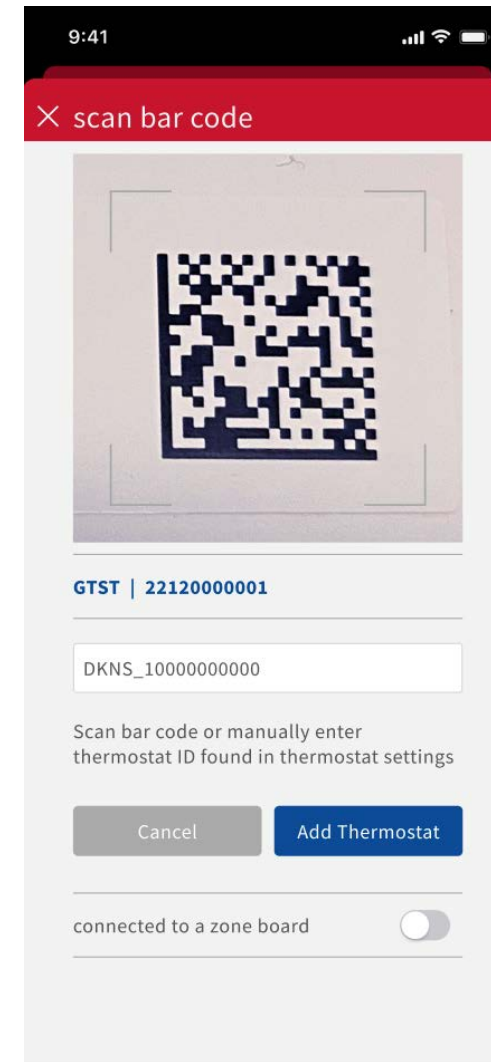

# Connect To The Thermostat Using AP Mode

- On selection of any task, internet connection will need to be verified before the user can continue setup.
  - If the Wi-Fi icon is grey, the system is not connected to Wi-Fi.
- To connect to Wi-Fi, first click on “apply system profile”
- On the thermostat, press and hold the fan button for 5 seconds.
  - Release the fan button and press the down button to continue.
  - Approximately 10 seconds to enter AP mode.
    - AP mode must be active before tapping discover device.
  - When connecting to the thermostat's access point, the mobile device **MUST** be within two feet.

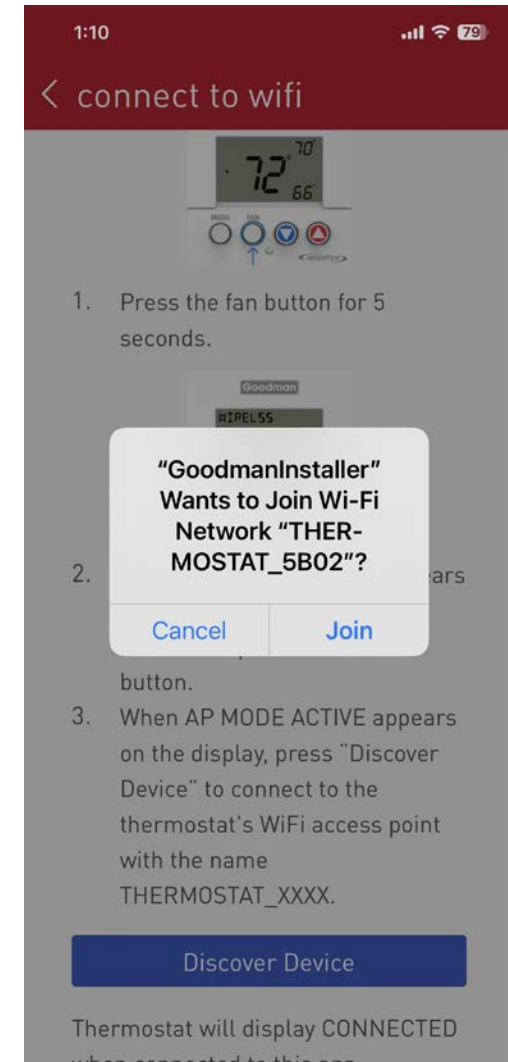
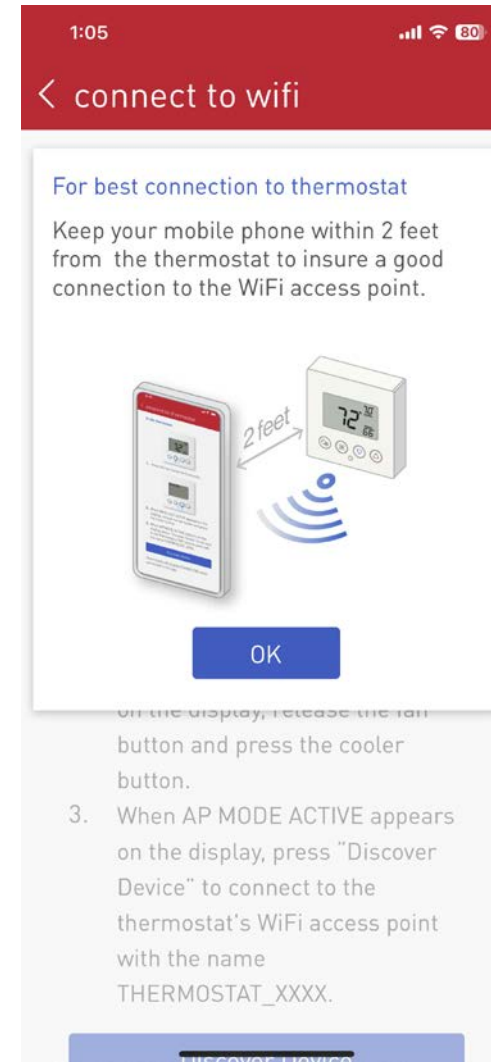
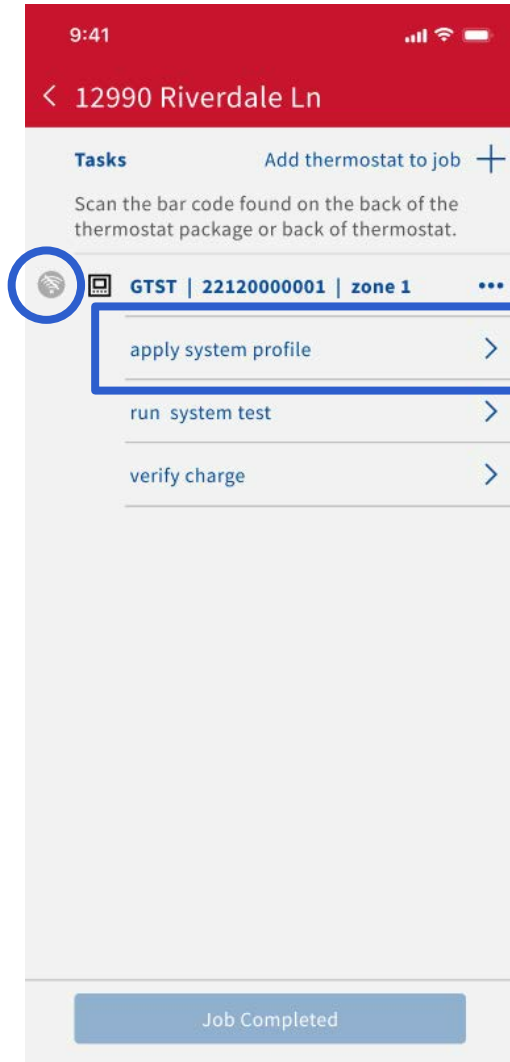

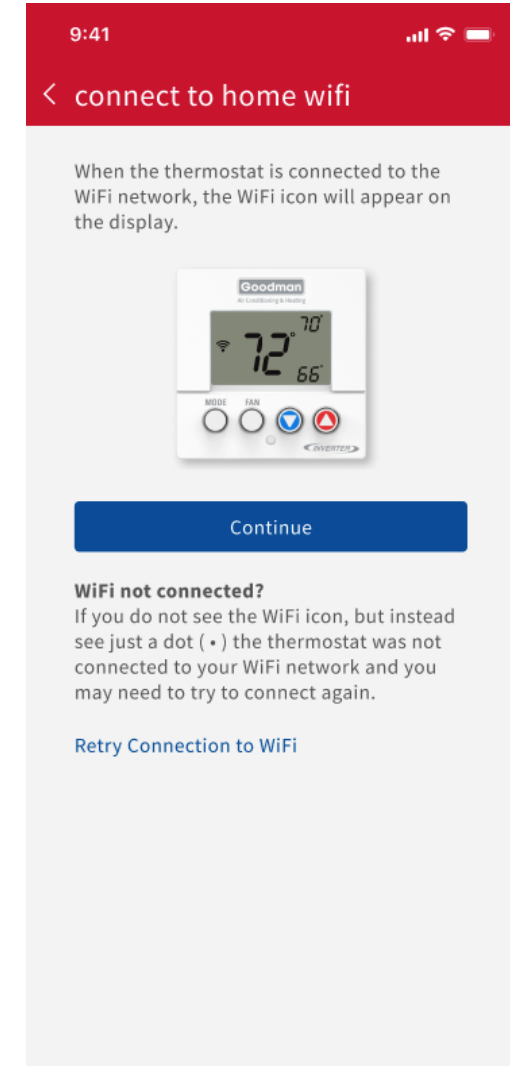
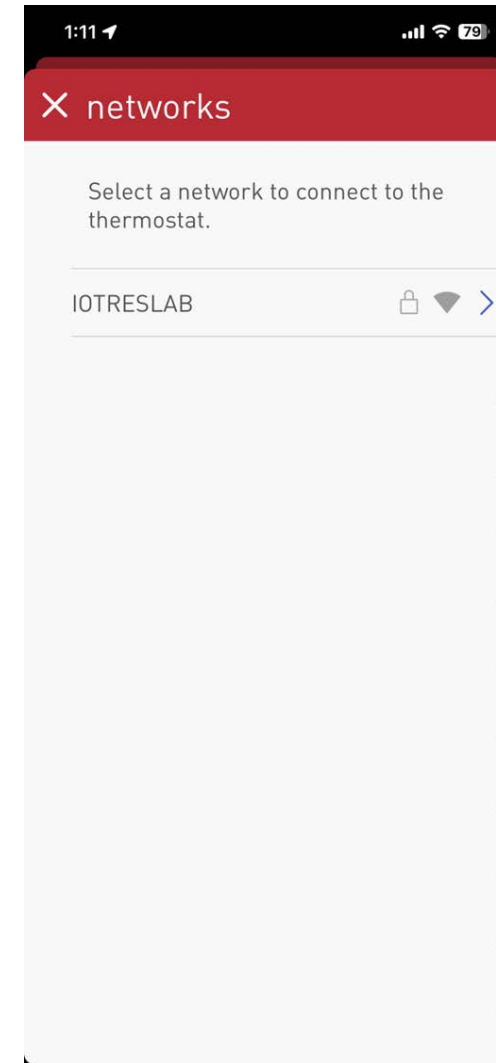

# Connect To Home Wi-Fi

- Once connected to the thermostat, following the “Cloud Commissioning” process, the user can connect to a local Wi-Fi network and no longer need to maintain a 2ft. distance from the controller.
  - Must be password protected.



# Apply System Profile

- A list of the connected equipment will be populated once connected to Wi-Fi.
  - Verify equipment, then continue to view thermostat profile options.
  - Once connected to Wi-Fi, the green  icon will be displayed. If access is expired, then the user will see the no access icon .

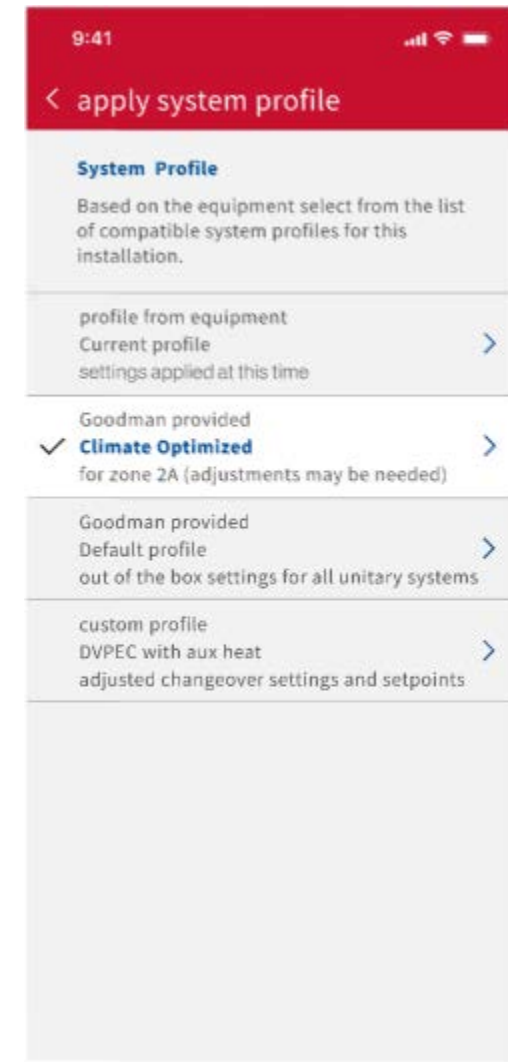
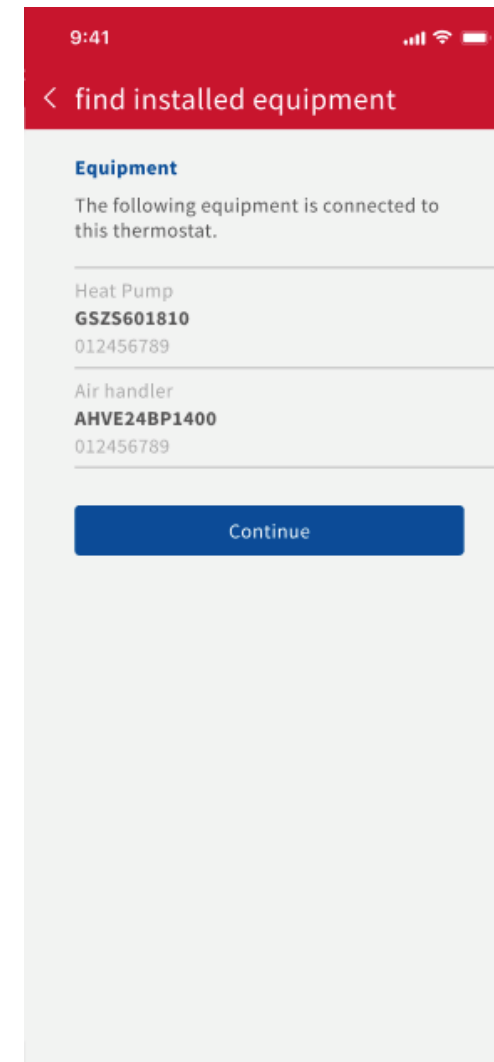
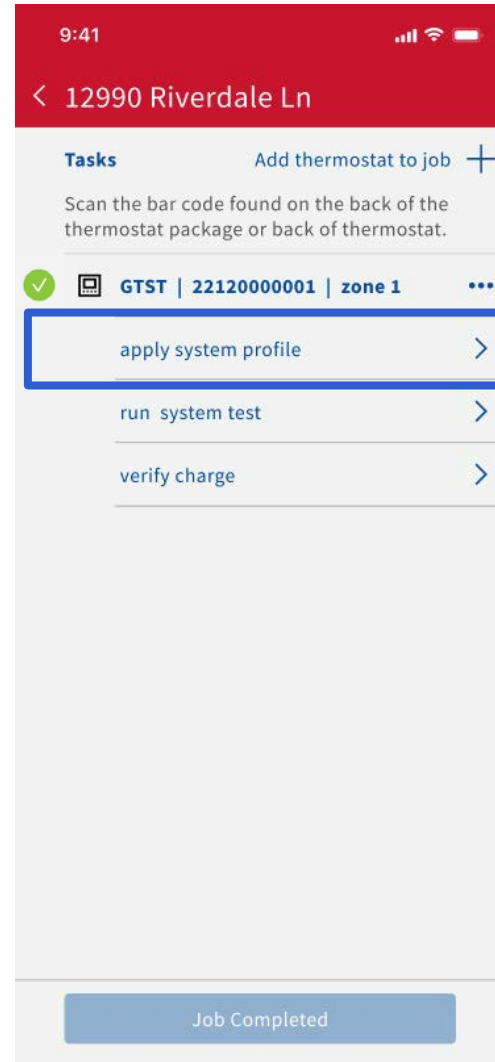



# Apply System Profile (continued)

- You can select and or modify any profile to send to the thermostat.
  - Make edits as needed, then tap “Send to Thermostat”

**NOTE:** Modifying the profile does not affect the default profile

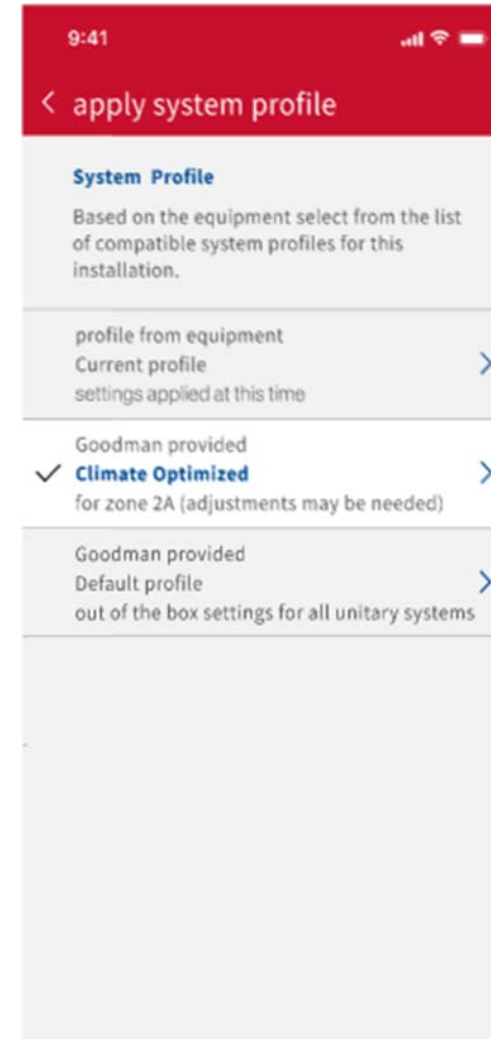

# Run System Test

- Running system test will prompt the user to calculate the charge before running the test.
  - Measure total line set length, then select liquid and suction line diameter before calculating required trim charge.
  - Input the actual charge weighed in.

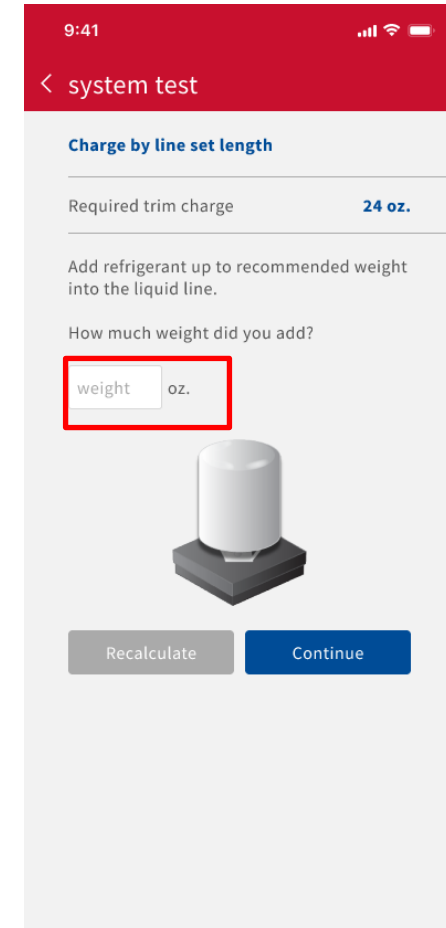
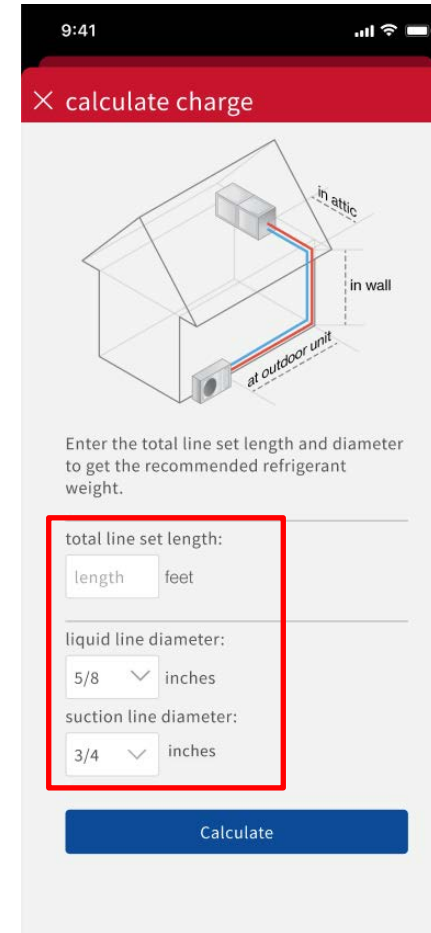
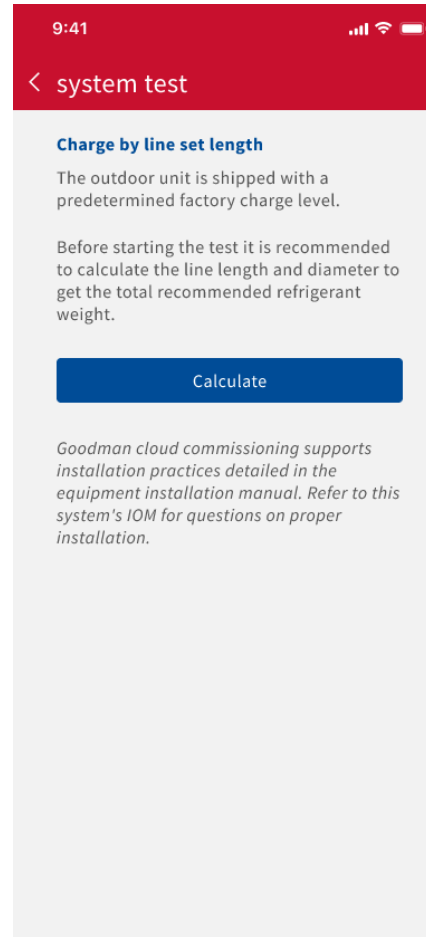
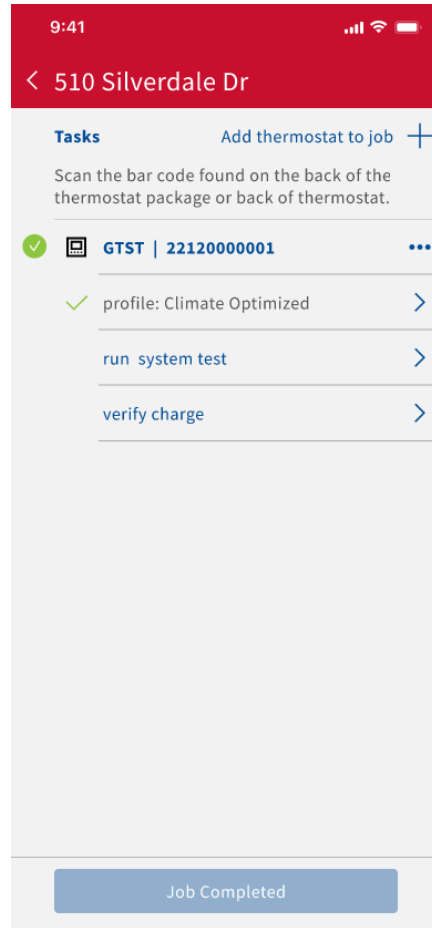



# Run System Test

- Verify service valves are open.
  - Tap “Run Test.”
  - Users can leave the screen while the test is running and return as needed.
  - System test is required for inverter systems.
    - If the test has not been completed an error code "11" will be generated.
    - Error code "11" will clear once the test is complete.

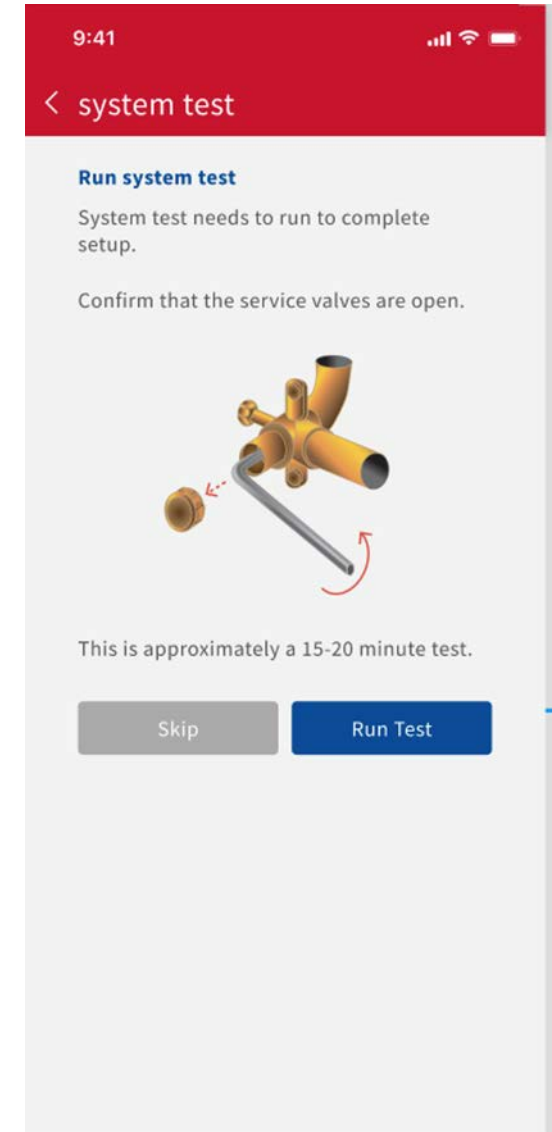

# Run System Charge Verification

- Recommended charge to be added to meet required charge displayed.
- Measure subcooling and verify proper specifications are met utilizing the charging chart in the IOM.
- Once system stabilizes and is running at full speed, the calculated subcool will be displayed.
  - Allow up to 5 min delay between gauge reading and app. verification.
  - Stopping the verification will generate a report.

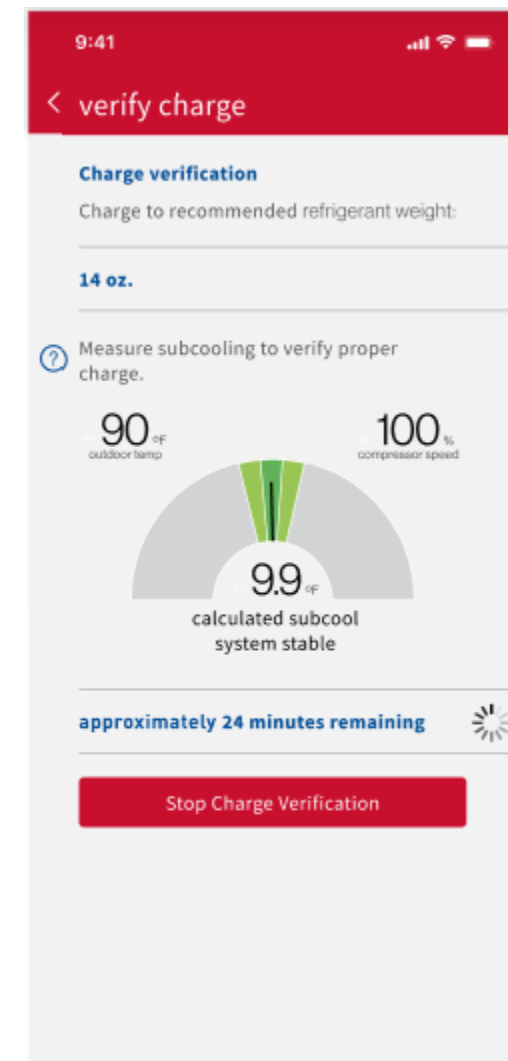
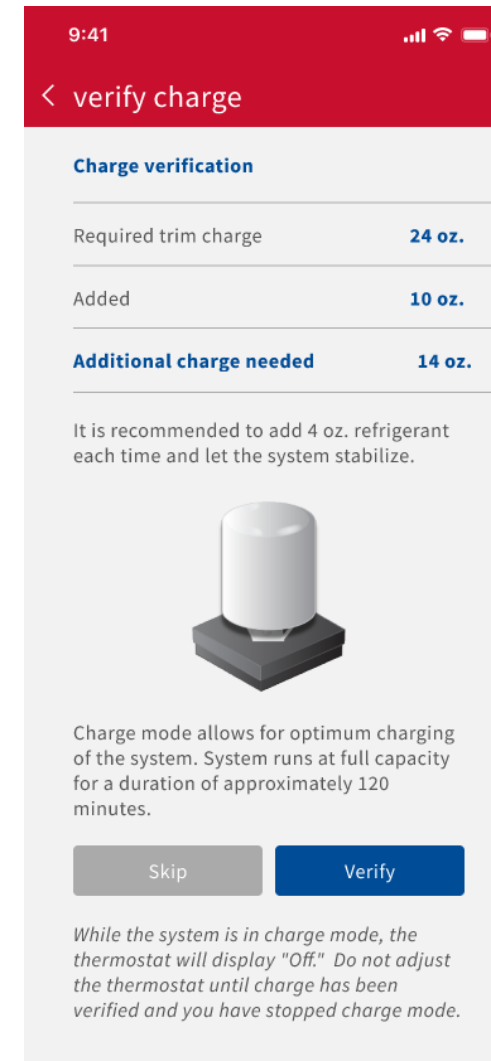
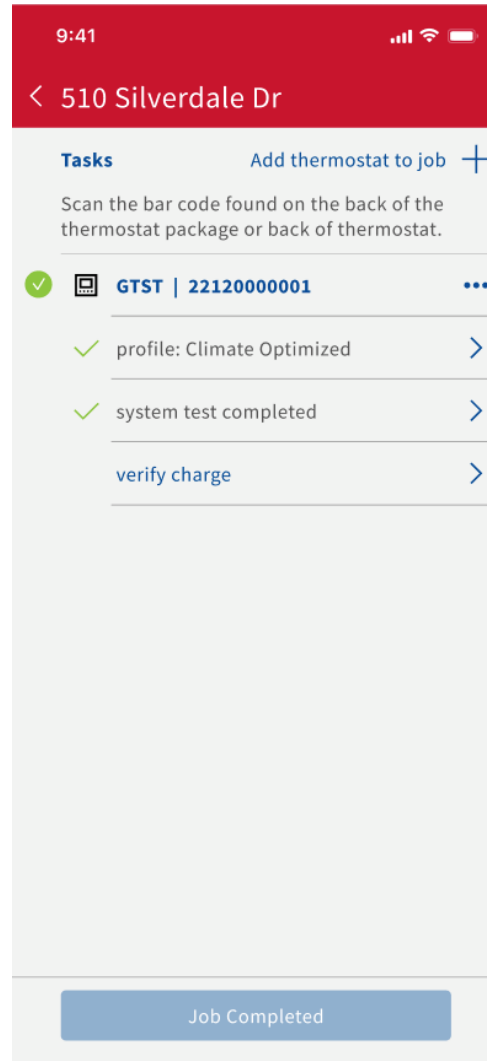

# Complete Setup

- After all steps are complete, the user will be able to share a commissioning report before completing the job.

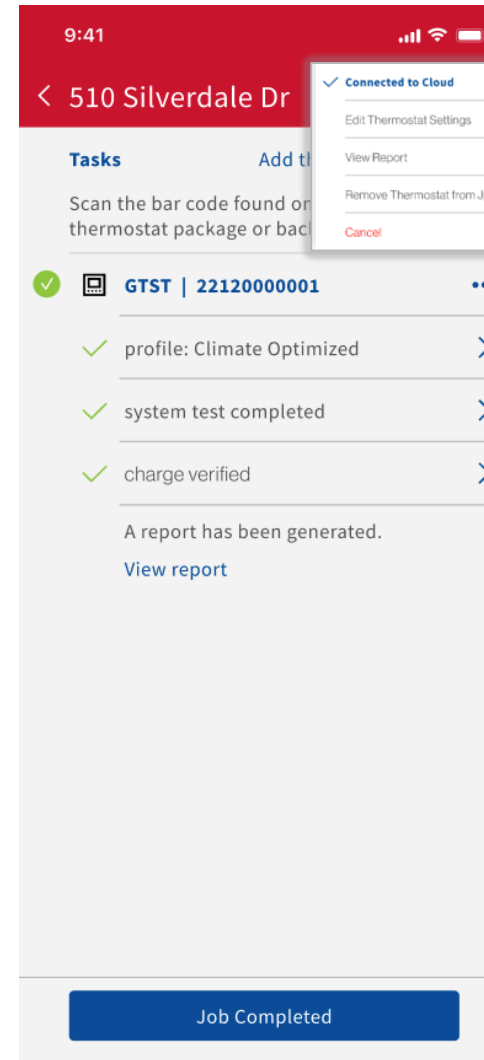

## Agenda

Goodman GTST

System Configurations

Installing Goodman GTST

Commissioning Goodman GTST with Wi-Fi (recommended)

**Commissioning Goodman GTST without Wi-Fi**

Goodman Home App

## Apply System Profile (without Wi-Fi)

- Download the Goodman Installer app. from your respective app. store.
- You do not need to create an account to log in
  - User ID and password (case sensitive):
    - User = Goodman
    - Password = Dealer
- System profiles enable the technician to modify settings from the app. and upload those settings to the thermostat.

Download the  
Goodman Installer app



Available on the App Store and Google Play

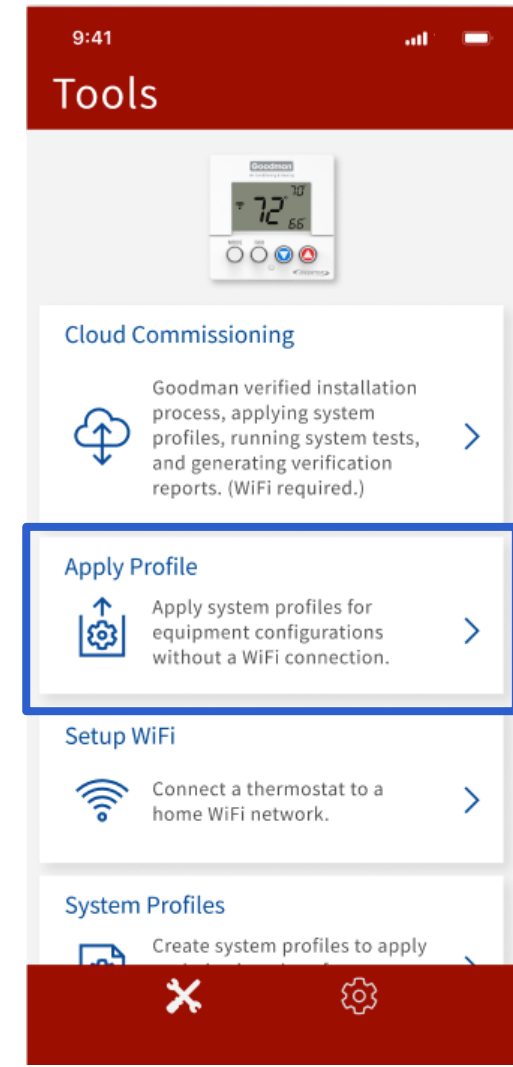
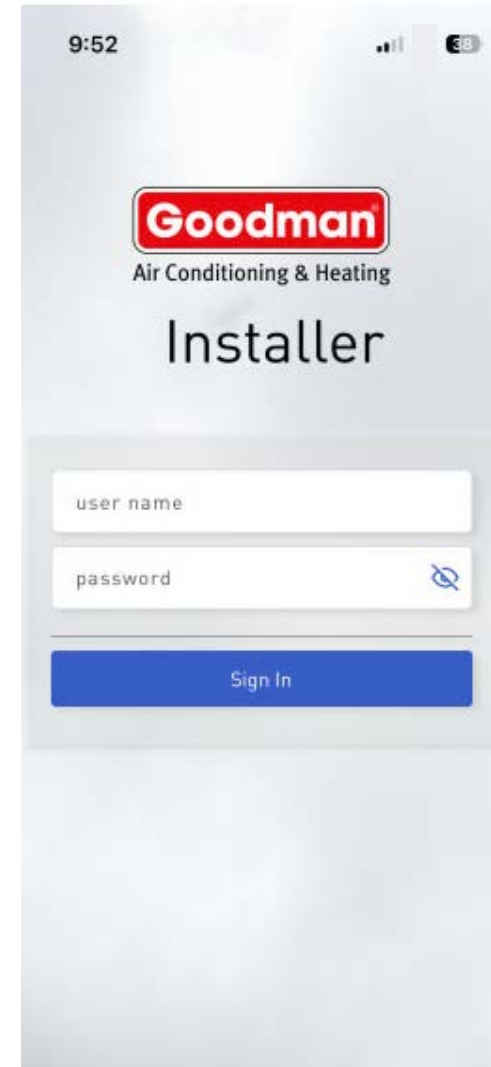

Must have Wi-Fi enabled on your mobile device without a network connected

# Connect To The Thermostat Using AP Mode

- On the thermostat, press and hold the fan button for 5 seconds.
  - Release the fan button and press the down button to continue.
  - Approximately 10 seconds to enter AP mode.
    - AP mode must be active before tapping discover device.
  - When connecting to the thermostat's access point, the mobile device **MUST** be within two feet.

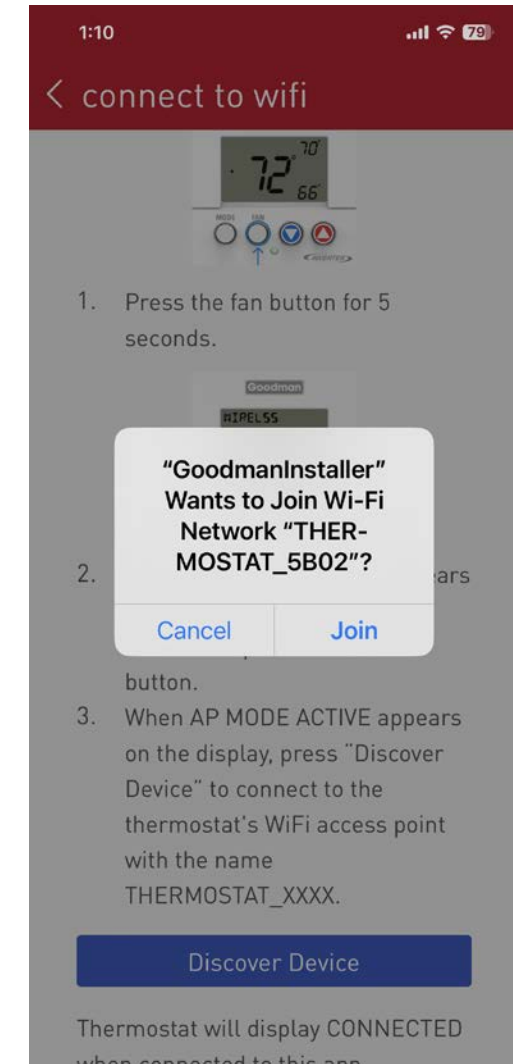
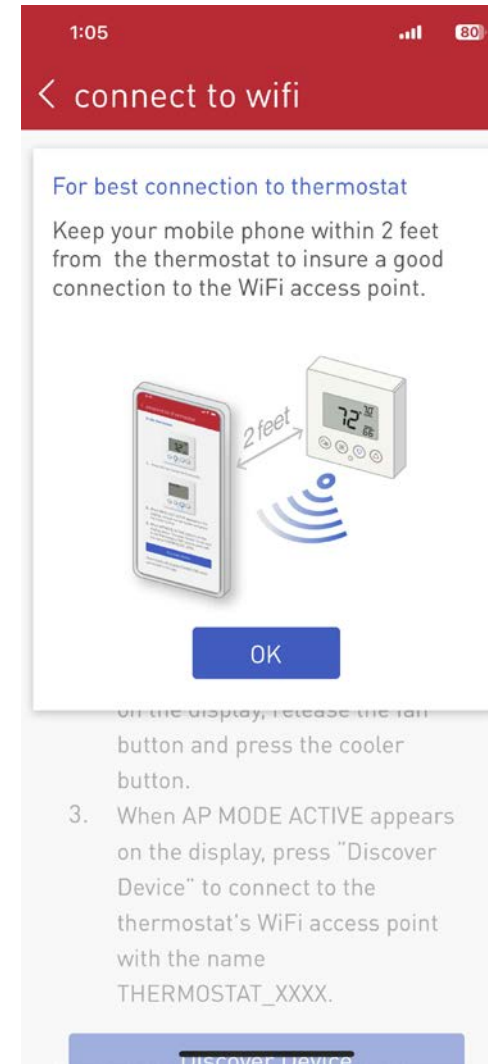

# Apply System Profile

- A list of the connected equipment will be populated once equipment settings are detected (may take several minutes).
  - Verify equipment, then continue to view thermostat profile options.

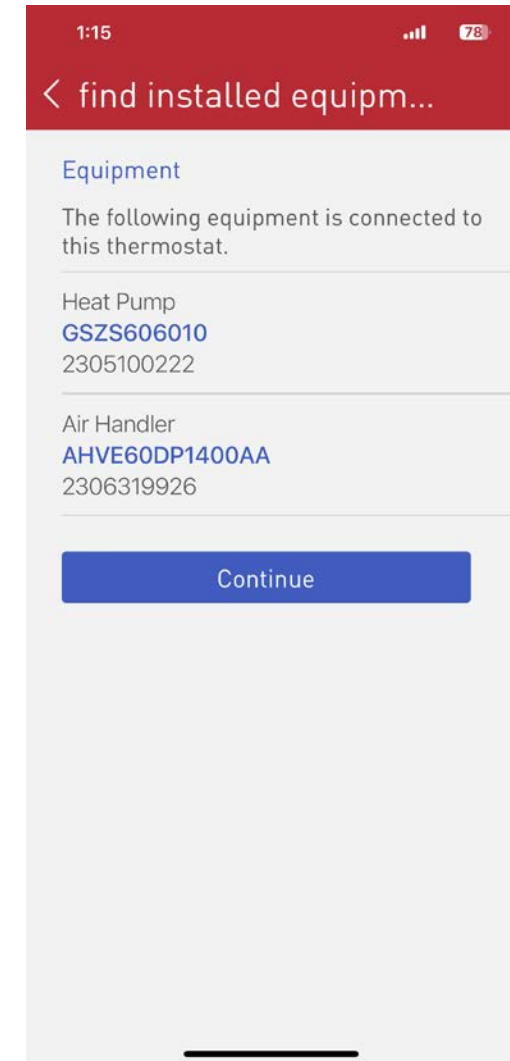
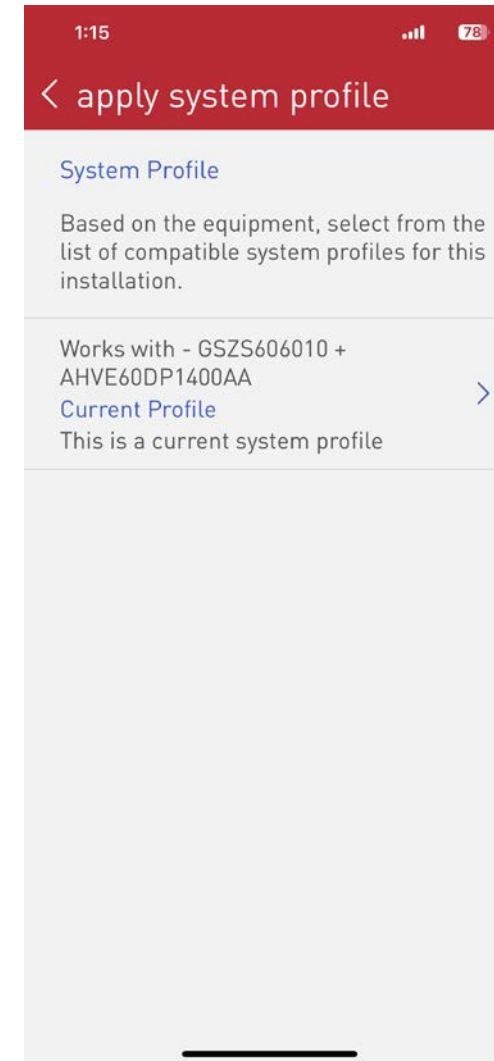

# Apply System Profile (continued)

- You can select and or modify any profile to send to the thermostat.
  - Make edits as needed, then tap “Send to Thermostat”
  - Without being connected to a network, the user **MUST** be within two feet of the thermostat.

**NOTE:** Modifying the profile does not affect the saved profile

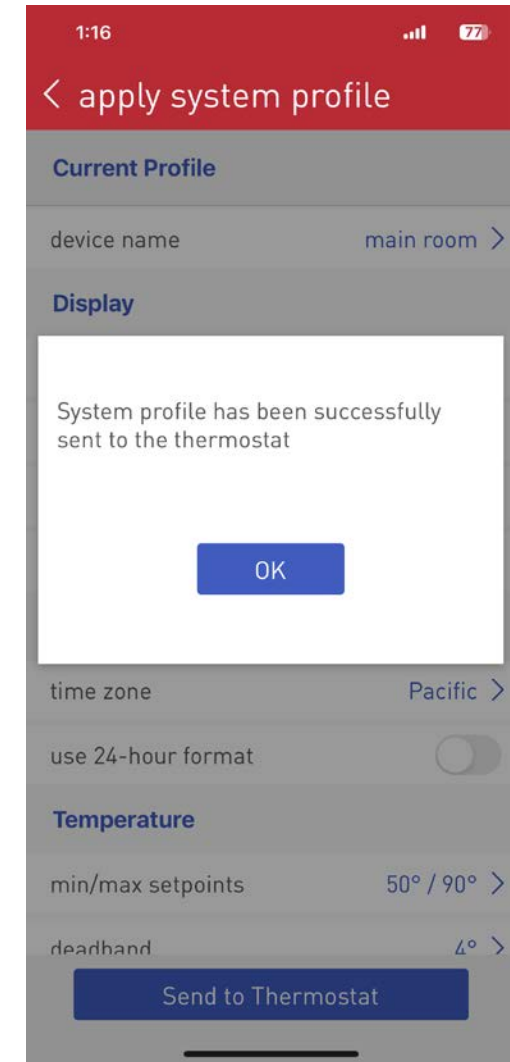
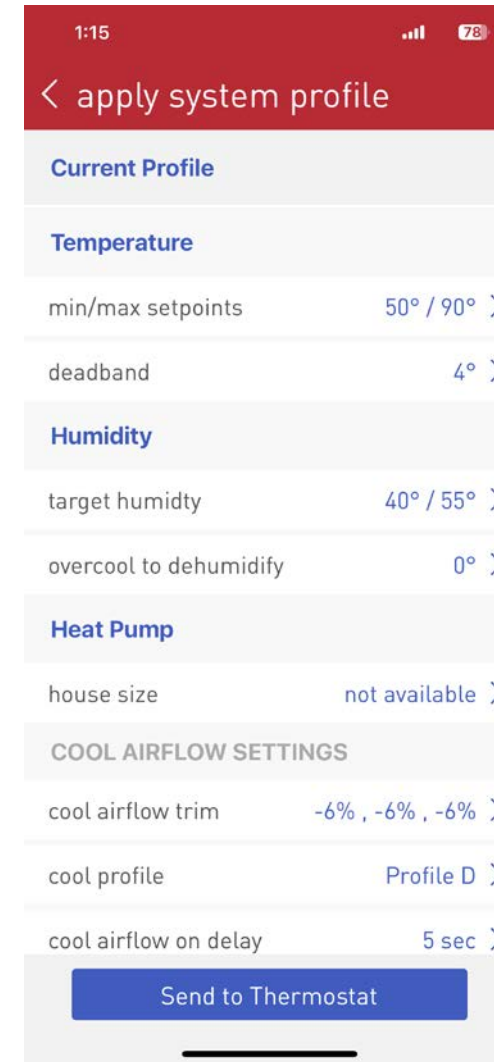
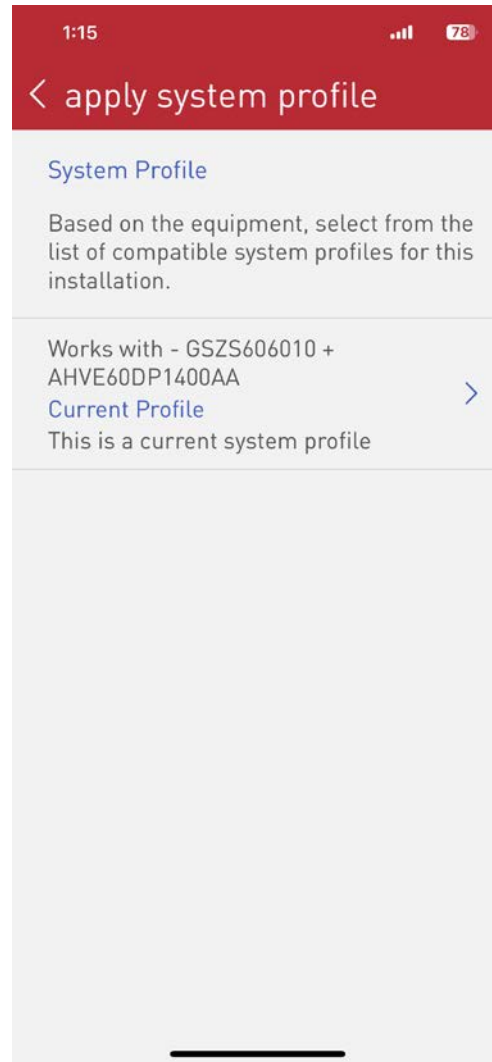



## Running System Test (without Wi-Fi)

- On the thermostat, press and hold MODE/FAN buttons at the same time for 5 seconds to enter setup options.
- Navigate to step 20 by pressing the MODE button.
- Hold the FAN button for approximately two seconds will turn system test on.
  - The system test cannot be stopped once started. This test should take about 15 minutes to complete.
- The display will cycle through the message, “System Test Running” while testing.
- When the system test is complete, press the MODE button to return to the main menu.

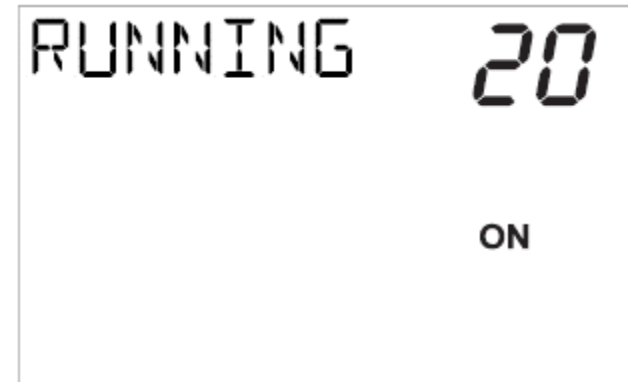
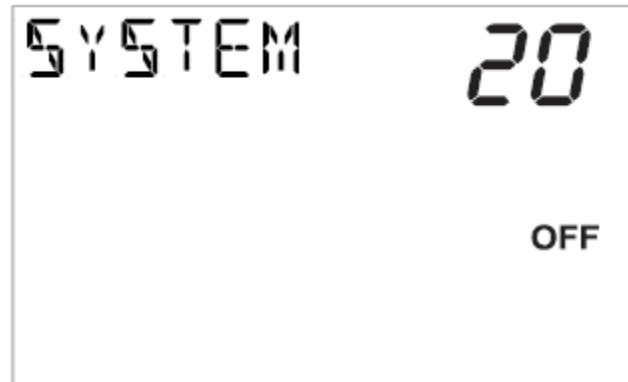
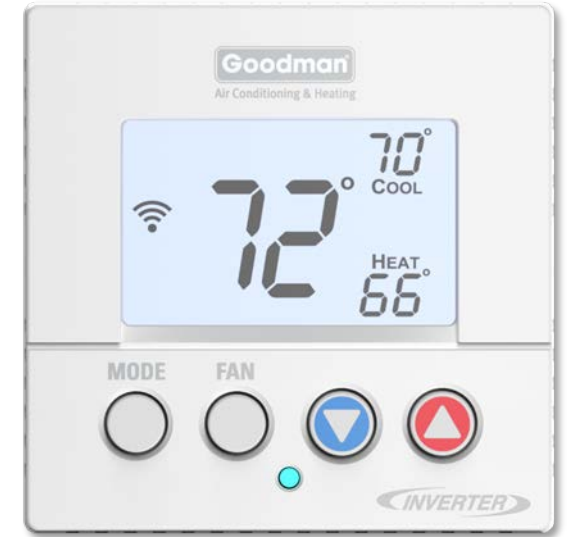



## Agenda

Goodman GTST

System Configurations

Installing Goodman GTST

Commissioning Goodman GTST without Wi-Fi

Commissioning Goodman GTST with Wi-Fi

Goodman Home App

# Account Set-up

- Setting up an account is a four-step process.
  1. Downloading the application from your IOS or Android application store.
    - Creating the account.
  2. Confirming your account.
  3. Adding the thermostats' location.
  4. Connecting the app to the thermostat.

**Note:** A mobile device, the **GTST** connected to **Wi-Fi** that is wired to a **communicating system** and a valid **email address** is needed to create a mobile account.

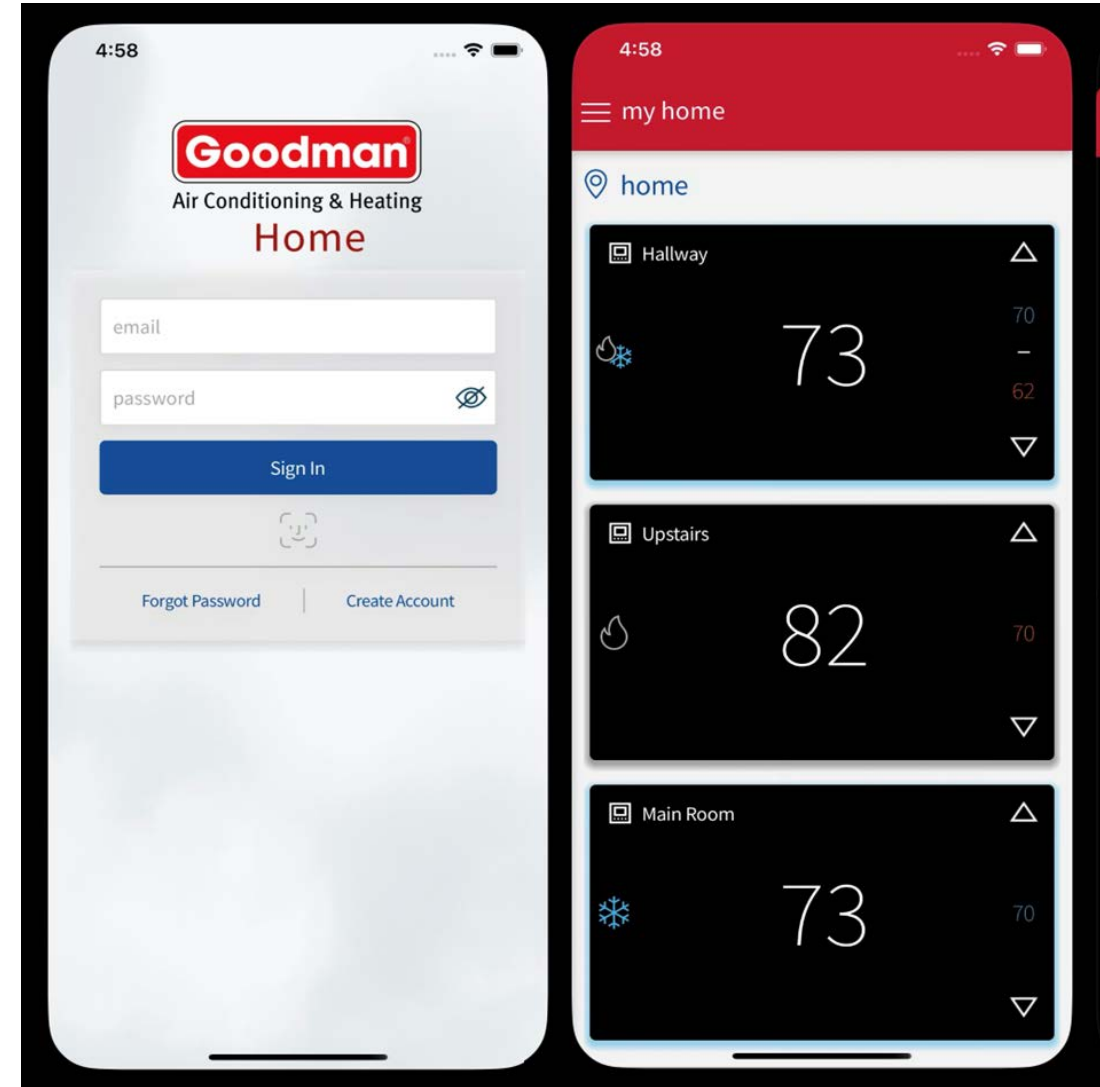

# Step 1 - Create The Account

- Tapping **create account** at will start the process.
- **Before** agreeing, read the terms and service, privacy statement, and other notices.
- Fill in your name, valid email address, and password.

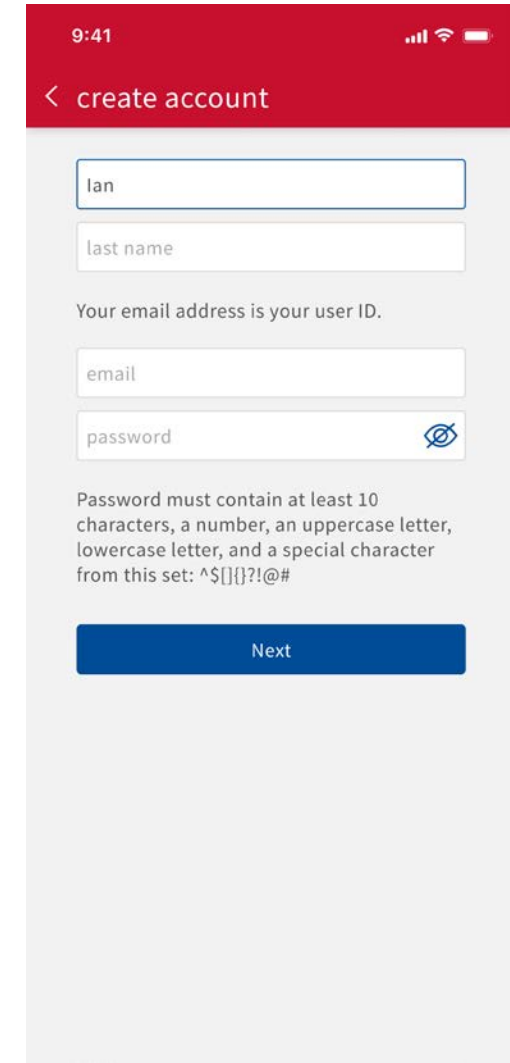
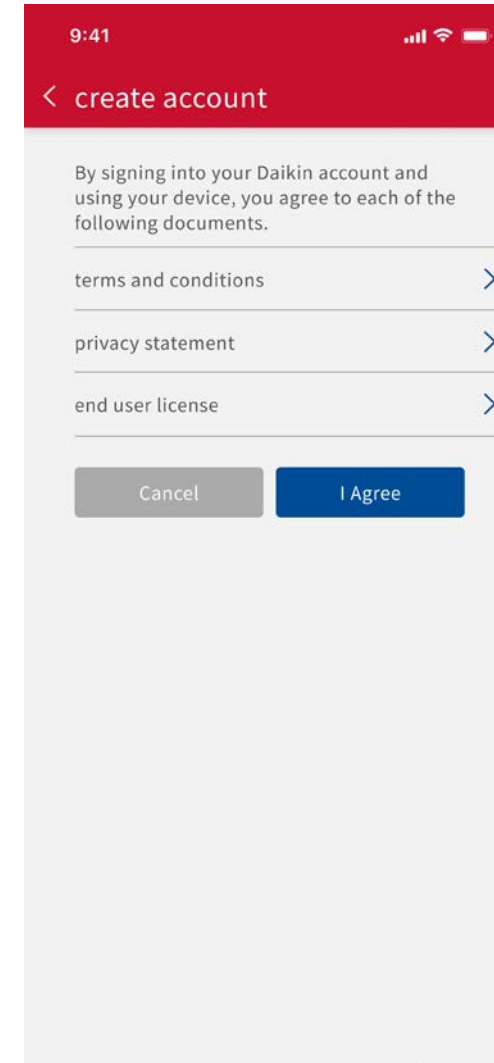
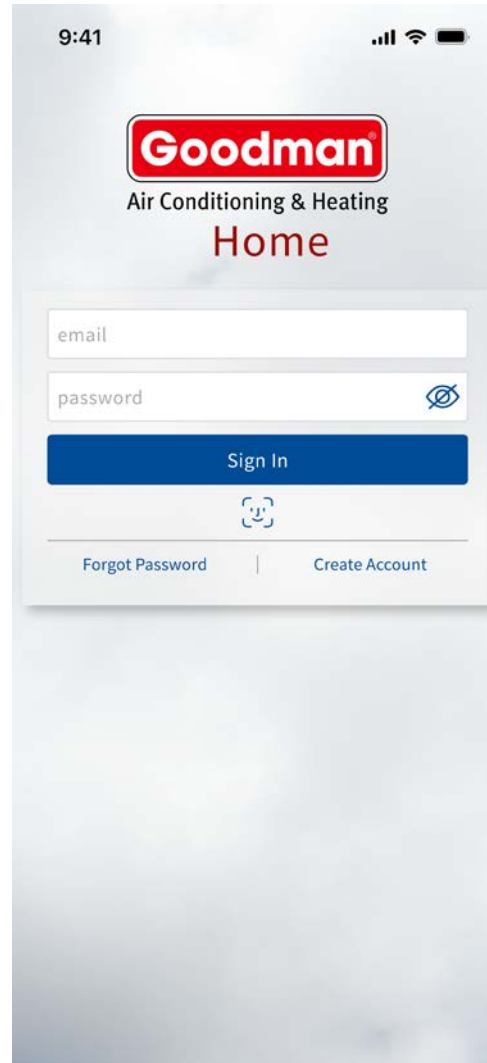

## Step 2 - Confirming The Account

- You will be prompted to access the **email address** you provided when creating the account.
- A welcome email will appear in your inbox providing a **six-digit** code.
- Entering the six-digit code on your phone app. will allow you to continue.

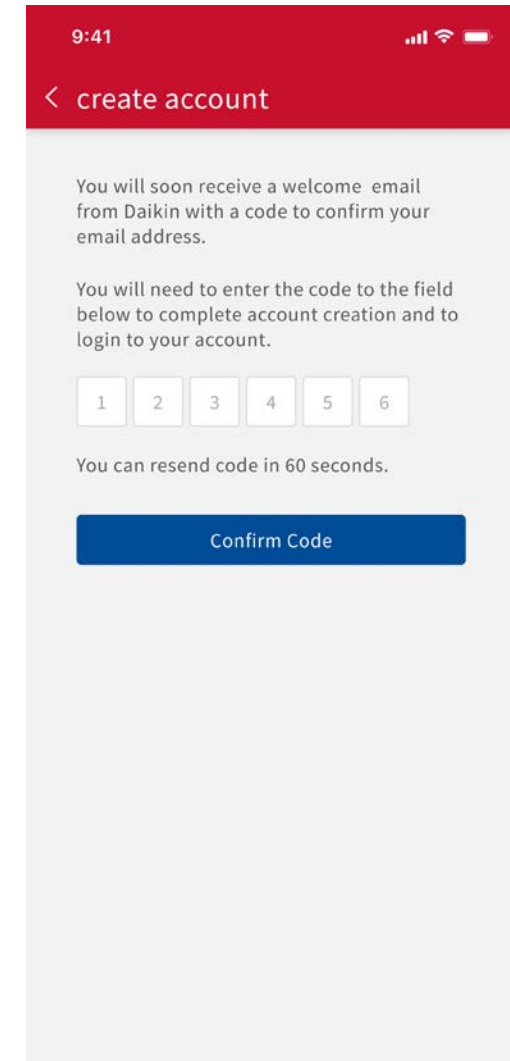
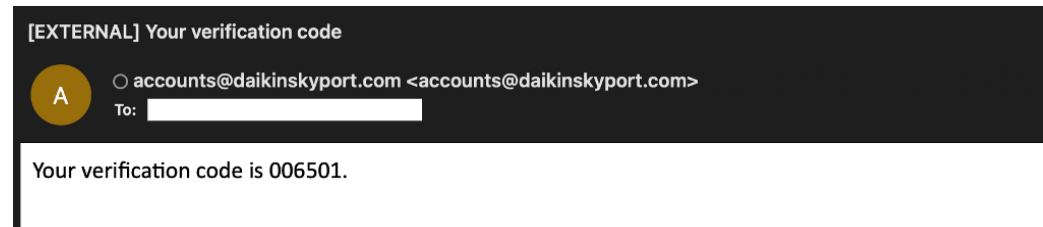

## Step 3 - Adding The Thermostat's Location

- Tap the login button and enter the email and password associated to your mobile account and.
  - If you have forgotten your password, tap the forgot password link to recover information via email.
- Type the address of where the thermostat is located to gather accurate information.
- Click Save This Location

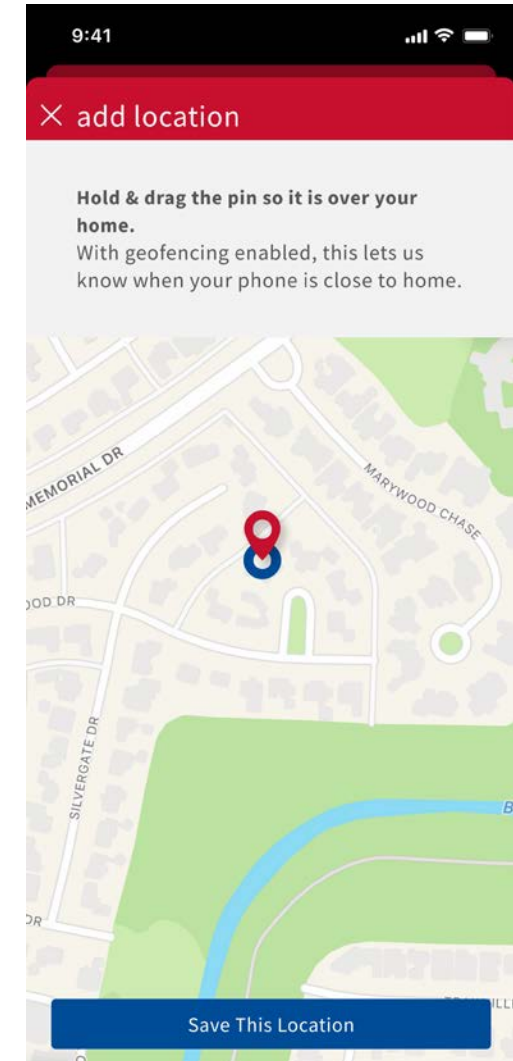
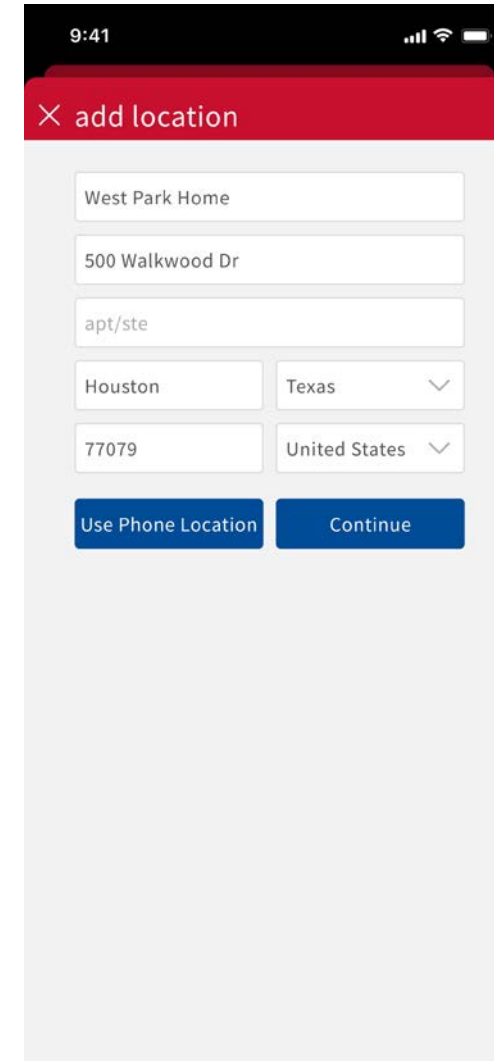
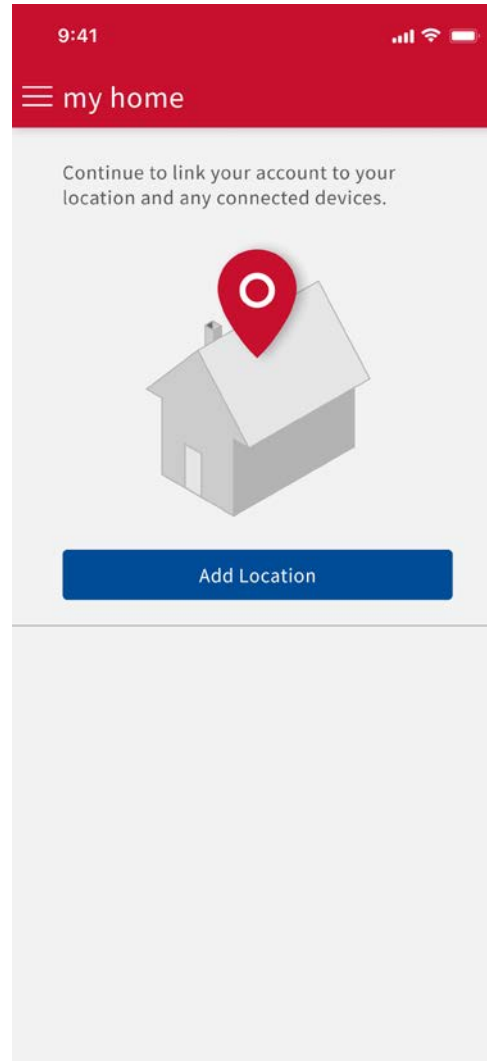



## Step 4 - Connecting The App. To The Thermostat

- Tap the added location and select “add thermostat”.
- Once the thermostat has been selected in the app., press and hold the fan button on the thermostat until the words “wireless setup” appears.
  - Select next on the mobile app. after “wireless setup” appears.

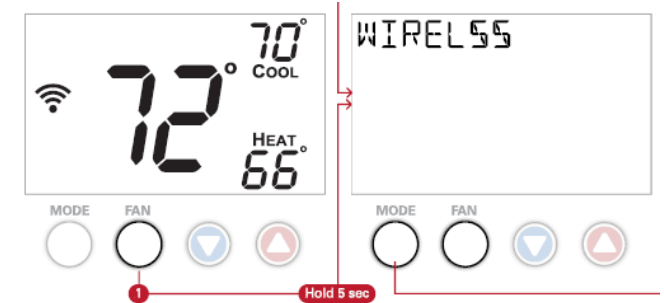
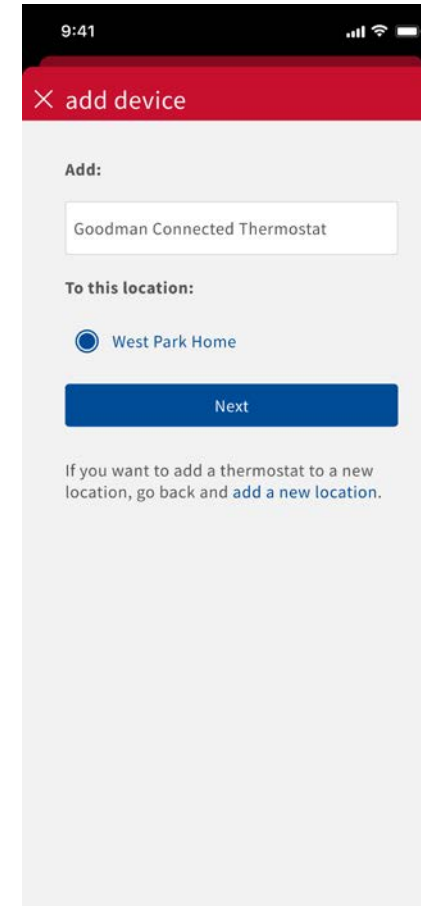
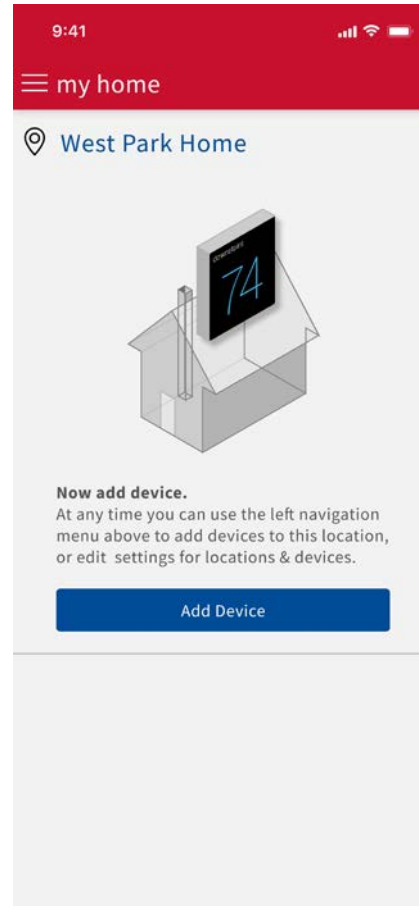



## Step 4 - Connecting The App. To The Thermostat (Cont.)

- On the thermostat, press the warmer button to reveal the six-digit code.
  - Select next on the mobile app. after code appears.

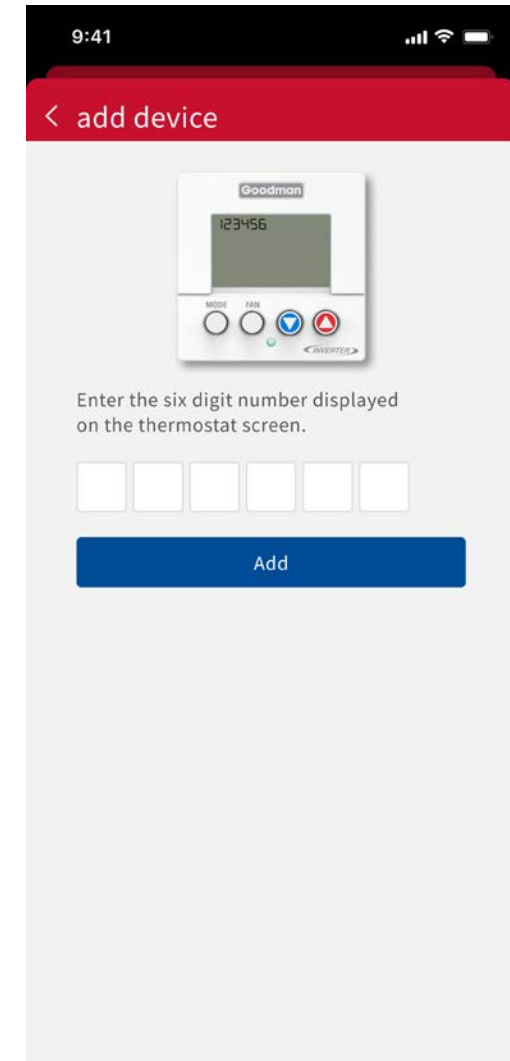
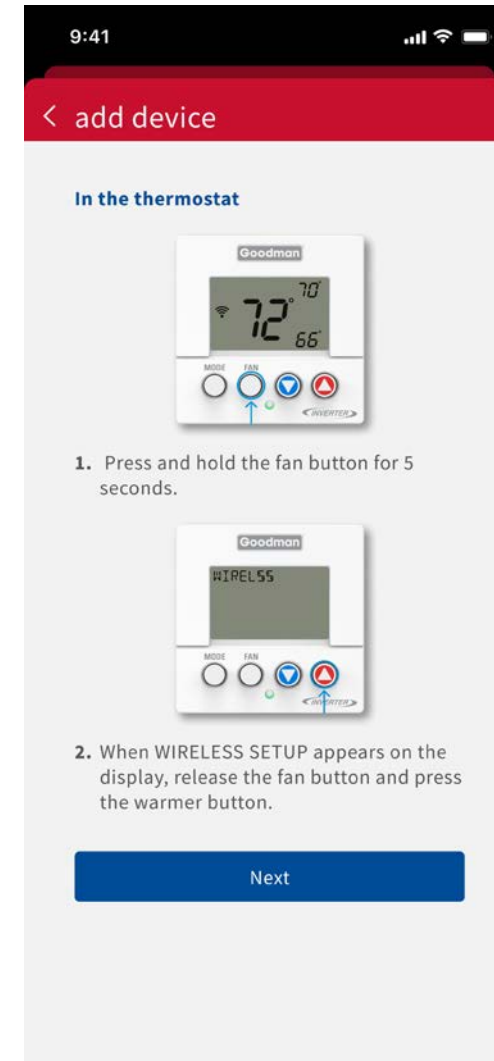

## Step 4 - Connecting The App. To The Thermostat (Cont.)

- In the mobile app., enter the code displayed on the thermostat and select “add”.

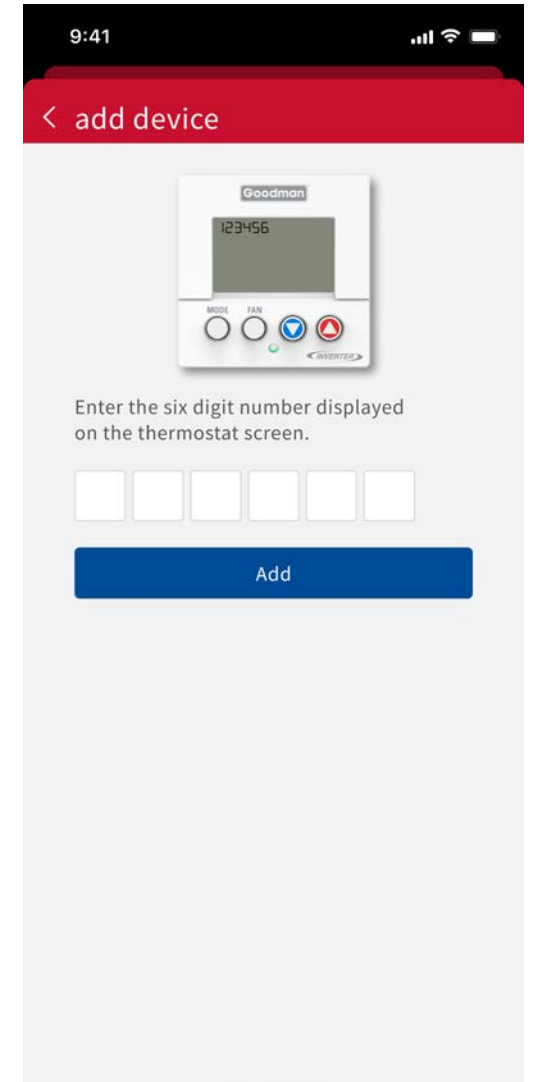

# Resource

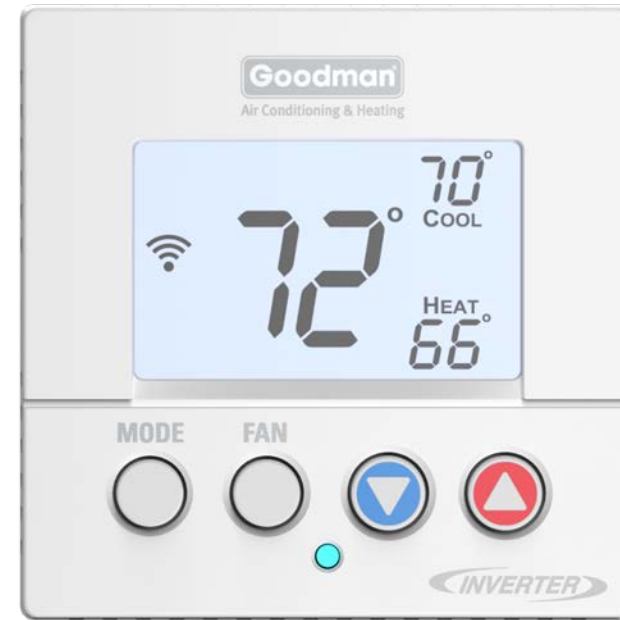
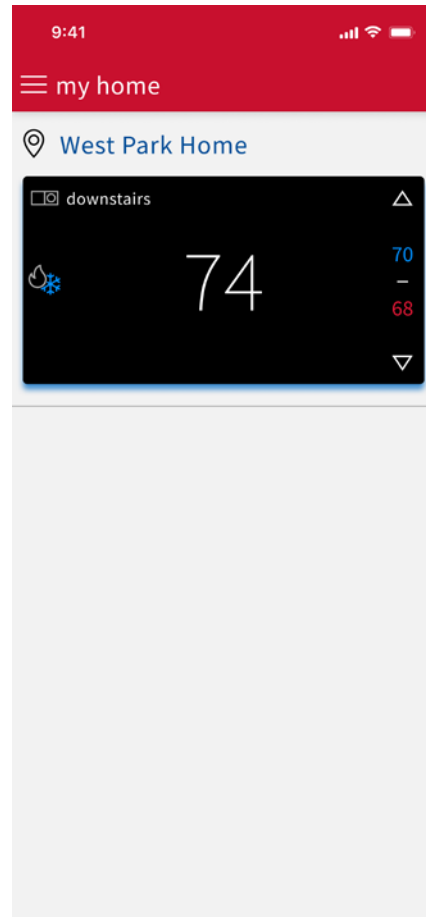

Visit [Goodmanmfg.com](http://Goodmanmfg.com) for additional information

**Thank goodness for Goodman.®**

